

PRODUCT DATA SHEET



PRODUCT CODE

GD112DNF

RANGE

GLIDE II

DESCRIPTION

Basin Mono Brushed Brass

MIN. PRESSURE 1 Bar

MAX. PRESSURE 5 Bar

PRESSURE (BAR) **FLOWRATE**

LOW 0.2 1.4

MID 0.5 2.34

1 3.35

HIGH 2 4.38

3 4.38

COLOUR Brushed Brass

MATERIAL Brass

FINISH APPLICATION PVD

INSTALLATION TYPE Deck Mounted

STANDARDS EN200:2008

HEADWORK 35mm Single Lever
Ceramic Cartridge

INLET CONNECTIONS THREAD G1/2"

FLOW REGULATOR Perlator Coin Slot M24x1

TAP HOLES 1

WEIGHT 2.8kg

WARRANTY 15 Years

TECHNICAL DIMENSIONS

Dimensions in mm unless otherwise specified.

Tolerances (per material type) apply.

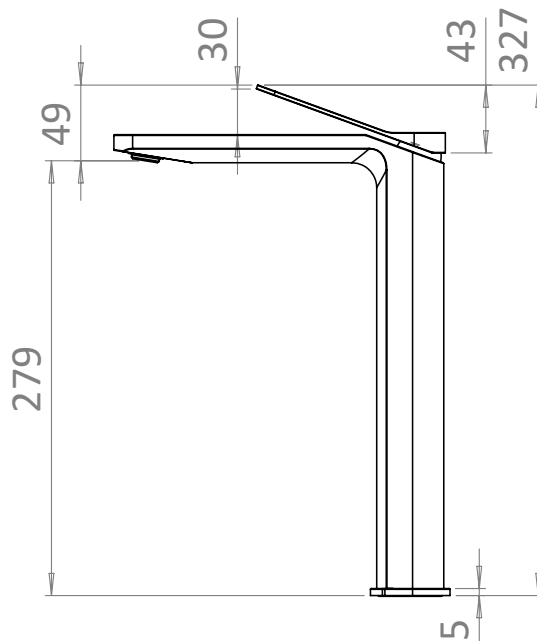
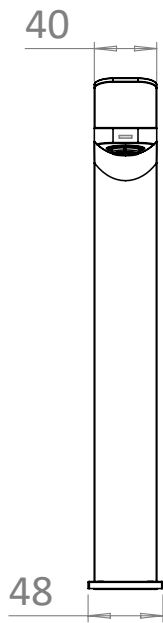
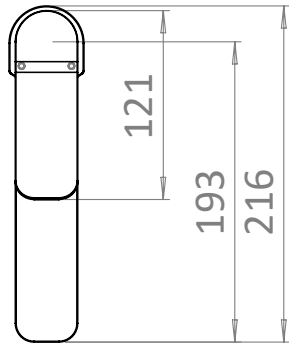

V11022

SPARES DIAGRAM

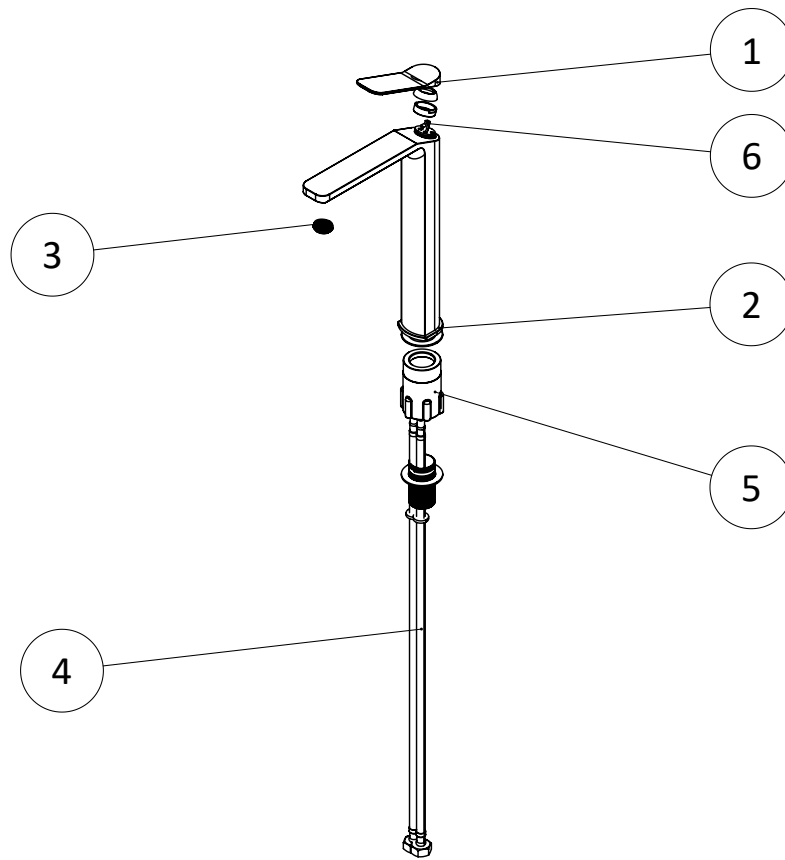

NUMBER	PART CODE	DESCRIPTION
1	A033110202	GD110/112V Stainless Lever
	A033110201	GD110/112M Matt Black Lever
	A033110200	GD110/112C Chrome Lever
	A033110203	GD110/112F Brushed Brass Lever
2	A033110302	GD110/112V Stainless Base Ring
	A033110301	GD110/112M Matt Black Base Ring
	A033110300	GD110/112C Chrome Base Ring
	A033110303	GD110/112F Brushed Brass Base Ring
3	B04001701	GD110/112/121 Aerator
4	B19001601	GD110 Flexible Hose (G1/2xM10x1-40CM)
5	B14000500	Glide & 3ONE6 110/112 Fixing Kit
6	B06004800	GD110/112 Cartridge

Only the parts labelled are available as spares.

V11022