

SPECIFICATION SHEET

COLLECTION: CAMEO
PRODUCT CODE: CAM-137-MW

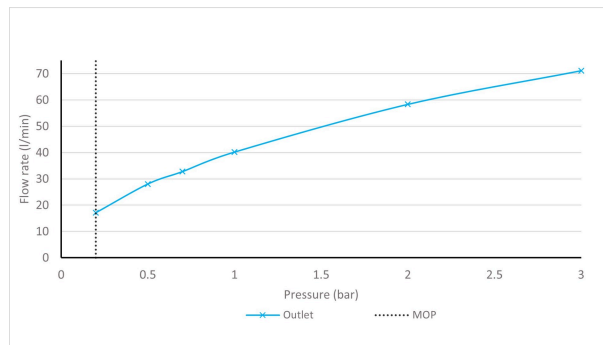

TAP TYPE

Basin Mixer

HANDLES

2 Handle

WITH WATER FLOW STRAIGHTENER

No

CONNECTIONS / FITTINGS

2 x 3/4" 48.5mm male threaded connections

SPARE PARTS

cold ceramic cartridge C-306-RTC, hot ceramic cartridge C-306-LTC

DECK HOLE DRILL DIAMETER

28-30mm

STYLE

Square

HOLES

2 Hole

MOUNTING

Deck Mounted

tel: 01934 744466
email: sales@vado.com
www.vado.com

WHERE INSPIRATION FLOWS
TAPS | SHOWERS | ACCESSORIES



SPECIFICATION SHEET

COLLECTION: CAMEO
PRODUCT CODE: CAM-137-MW

PLUMBING SYSTEM SUITABILITY

Gravity System

COLLECTION NAME

Cameo

FINISH

Matt White

MINIMUM OPERATING PRESSURE

0.2 Bar LP

GUARANTEE

10 Year Guarantee

tel: 01934 744466
email: sales@vado.com
www.vado.com

WHERE INSPIRATION FLOWS
TAPS | SHOWERS | ACCESSORIES



TECHNICAL DRAWING

COLLECTION: CAMEO
PRODUCT CODE: CAM-137-MW

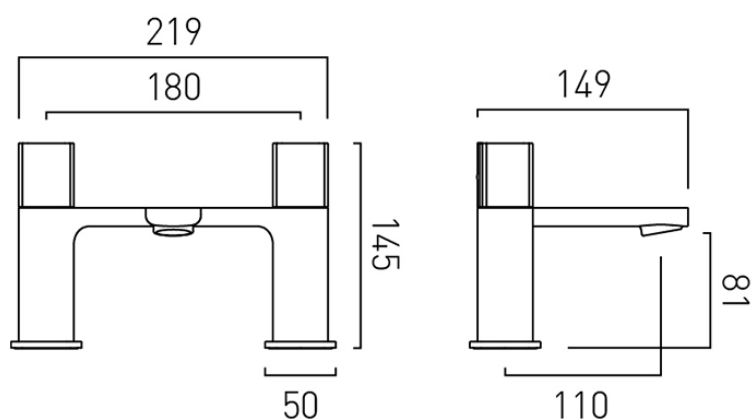

tel: 01934 744466
email: sales@vado.com
www.vado.com

WHERE INSPIRATION FLOWS
TAPS | SHOWERS | ACCESSORIES

