

## SHOWER TRAY ARCHITECTURA

### PRODUCT INFORMATION

#### 1. POSITION



|                          |   |
|--------------------------|---|
| <b>Article number</b>    | <b>UDA9090ARA115V-01</b>  |
| Article title            | Villeroy & Boch Architectura Square shower tray, 900 x 900 x 15 mm, White Alpin   |
| Product designation      | Square shower tray  |
| Collection               | Architectura  |
| PROJECTS                 | <span style="color: blue;">■</span> PLUS  |
| Assembly / Assembly type | Surface-mounted, Corner installation flush-fitting installation  Installation on a base   |
| Assembly instructions    | With MetalRim and an edge height of 15mm, we recommend the use of a composite seal in accordance with ETAG 022 on the floor structure below the shower tray in order to prevent any moisture from penetrating the floor structure., The installation height of the shower tray can be reduced by 30 mm if the Viega outlet fitting art. no. 634 100 is used. Please note: this outlet fitting does not conform to EN 274. |
| Drainage rate in l/min   | 53  |
| Scope of delivery        | 1 x square shower tray , 1 x outlet cover in White Alpine (01), for matt colours, outlet cover in matching matt colours.  |
| Ordering information     | Supplied without support frame / base.  |
| Length in mm             | 900   |
| Width in mm              | 900   |
| Height in mm             | 15  |
| Interior depth           | 17  |
| Weight in kg             | 11,00   |
| Material                 | Acrylic   |
| Colour name              | White Alpin   |
| With feet/base           | No  |
| Other material           | Outlet cover: Acrylic   |
| Other surfaces           | Outlet cover: glossy  |
| With bath support        | No  |
| Anti-slip class          | Anti-slip class A   |
| EAN number               | 4051202286323   |

COLOUR

COLOUR DESIGNATION



White Alpin

TECHNICAL DRAWINGS

UDA9090ARA115V-01

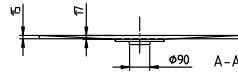
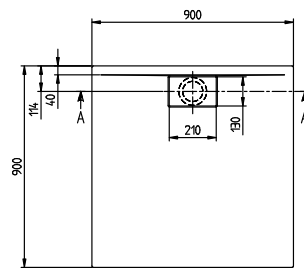

|                    |   |
|--------------------|---|
| ARCHITECTURA METAL | <br>Villeroy & Boch<br>1748 |
| RIM 900x900        |   |
| UDA9090ARA115      |   |
| V02 / 31-03-2021   |   |

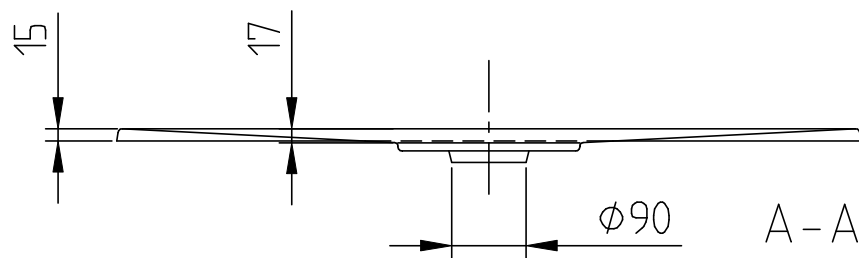
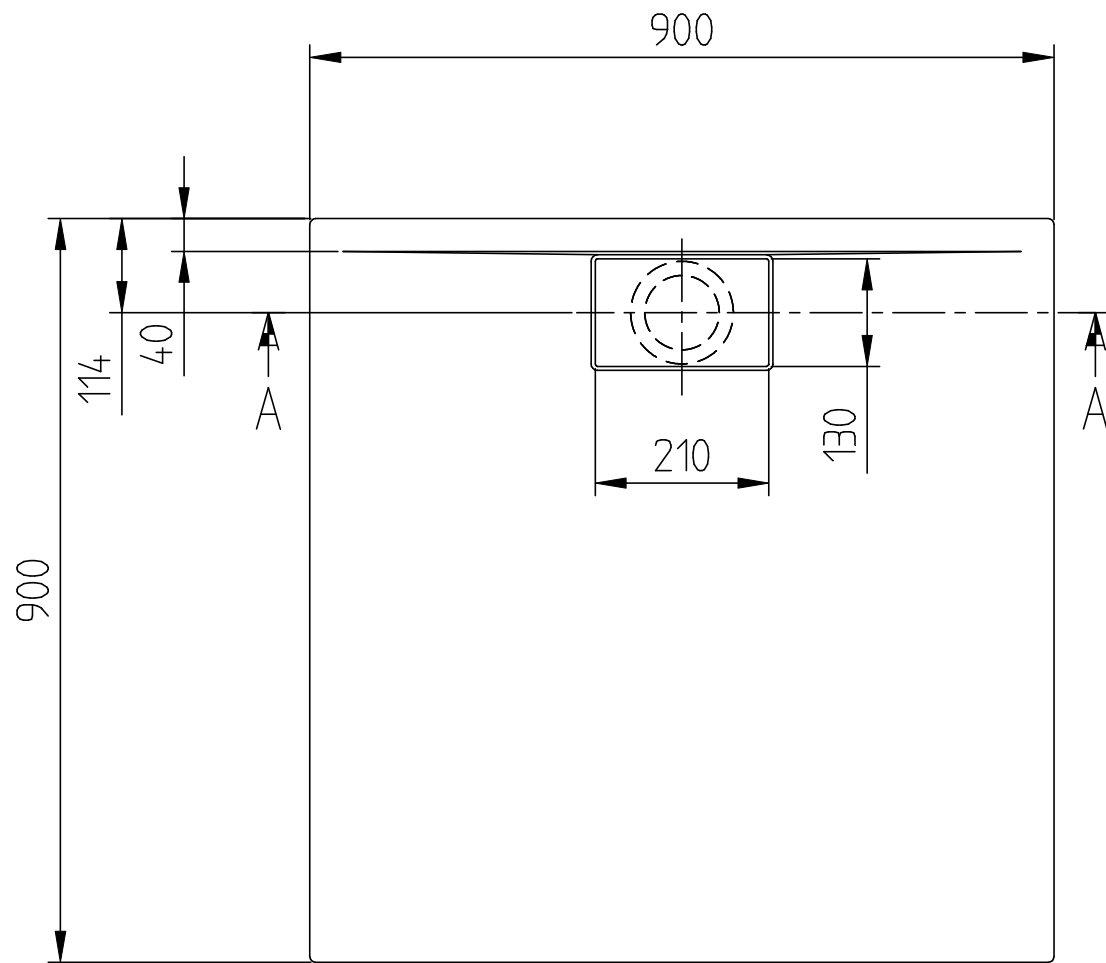

ARCHITECTURA METAL  
RIM 900x9000  
UDA9090ARA115

V02 / 31-03-2021



**Villeroy & Boch**  
1748



# ARCHITECTURA METALRIM.

ULTRA-FLAT DESIGN.  
OUTSTANDING STABILITY.



NEW PRODUCTS  
FOR 2014

# THE NEW GENERATION OF ULTRA-FLAT SHOWER TRAYS

Tested in compliance with EN 249

With 31 models, 2 rim heights, 2 finishes (standard or slip-resistant) and thus a total of 124 different options, Architectura MetalRim – the new generation of ultra-flat shower trays – it is possible to create individual designs and satisfy all manner of installation requirements whatever the bathroom layout. It is the first Villeroy & Boch collection to feature MetalRim technology: a galvanised steel profile is integrated along each of the four edges in the rim area guaranteeing maximum stability and material strength.



## HIGH-QUALITY MATERIAL

- Impact-resistant cast sanitary acrylic (PMMA), incorporating a high-strength, water-resistant composite
- Closed and pore-free surface for easy care and high-gloss finish
- Repairable surface
- Ten-year guarantee (standard finish) or two-year guarantee (slip-resistant finish)



## THE INNOVATIVE METALRIM

MetalRim technology: the integration of a galvanised steel profile along each of the four edges of the rim area



## MAXIMUM STABILITY TESTED TO A LOAD-BEARING CAPACITY OF UP TO 1000 KG

- Extremely robust thanks to MetalRim technology, which has been tested under conditions reflecting shower tray installation
- Assures perfect stability of the shower tray, even for XXL dimensions



## SAFETY: SLIP-RESISTANT FINISH, CLASS C, OPTIONALLY AVAILABLE

- Excellent grip across the entire shower tray surface for maximum safety
- Tested at a slope of more than 24° (PN 24)
- Easy to clean with soapy water



## MINIMALIST DESIGN

- Ultra-flat, rimless look
- Integrated flush-fit outlet, supplied in White as standard



## PLENTY OF CHOICE

- 31 models, 2 rim heights, 2 finish options
- In total, 124 options



## SAFE AND SIMPLE INSTALLATION

- Installation on the screed - flush with the tiling, on tiles or on a pedestal, 3 installation options for maximum flexibility
- Optional base frame for a sturdy stand



## BARRIER-FREE

Complies with current standards for barrier-free access thanks to various installation options



## A PRIME EXAMPLE OF TECHNOLOGY: METALRIM

CROSS SECTION OF SHOWER TRAY,  
RIM HEIGHT 15 MM



15 mm

High-strength, water-resistant  
composite material

Galvanised steel profile along the four  
edges in the rim area of the shower tray



4 mm thick cast acrylic with  
full-body colouring

CROSS SECTION OF SHOWER TRAY,  
RIM HEIGHT 48 MM

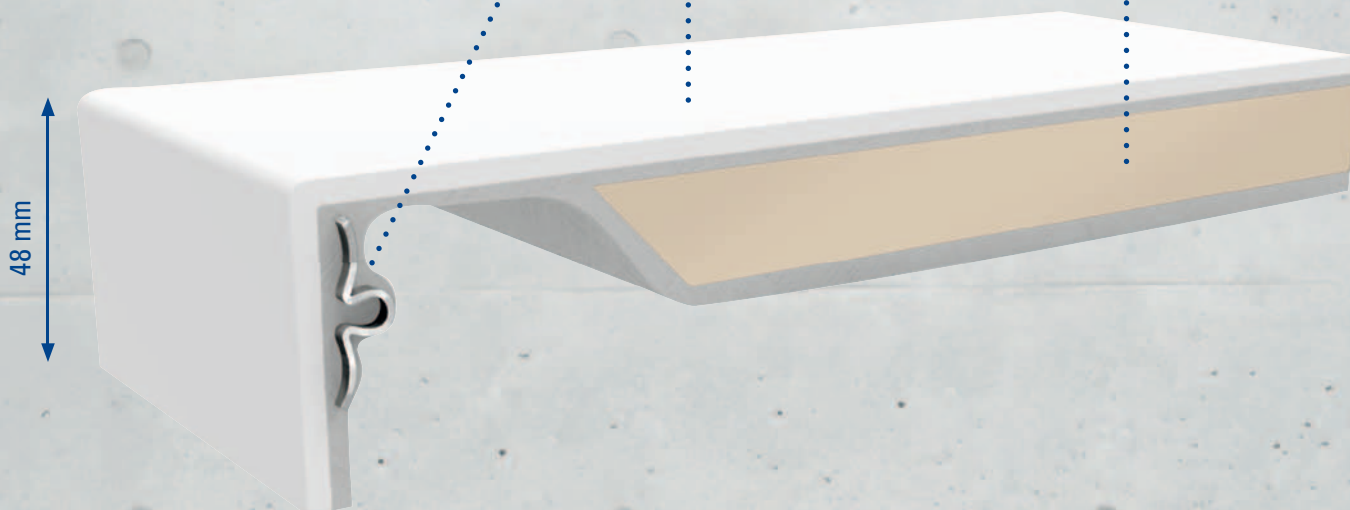

48 mm

# SIMPLE AND SAFE INSTALLATION FOR EVERY PROJECT

## RIM HEIGHT 15 MM

## RIM HEIGHT 48 MM

### INSTALLATION ON THE SCREED – FLUSH WITH TILING



- Installation of both shower tray and outlet in the screed
- Floor-flush sealant

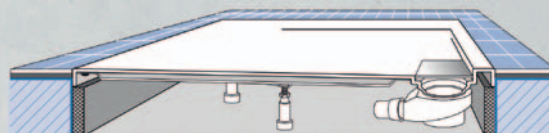

- Installation of both shower tray and outlet in the screed
- Floor-flush sealant

### INSTALLATION ON TILES

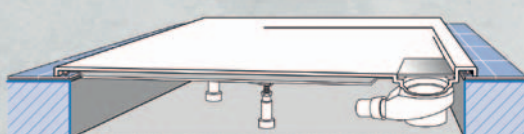

- Installation on tiles, with 15 mm rim height
- Installation of both shower tray and outlet in the screed

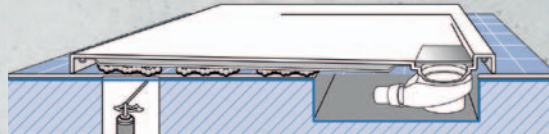

- Installation on tiles, with 48 mm rim height
- Installation of outlet in the screed

### INSTALLATION ON A BASE FRAME

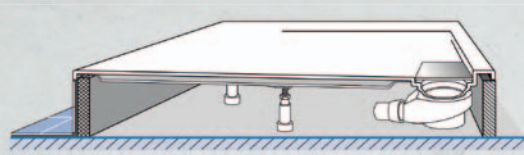

- Installation with shower tray feet
- Panel for tiling

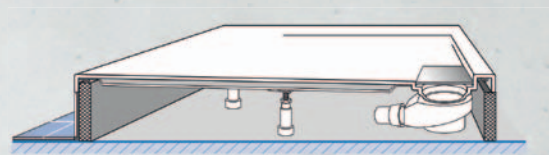

- Installation with shower tray feet
- Panel for tiling



Installation in compliance with standards for barrier-free access

## INSTALLATION ACCESSORIES



Chrome  
matt plated

Chrome  
plated

### WATER OUTLET COVER INTEGRATED FLUSH INTO SHOWER TRAY SURFACE, 130x210 MM

- Supplied in White as standard
- Optionally available in matt chrome or chrome-plated

### TEMPOPLEX PLUS OUTLET VALVE

- 90 mm in diameter, chrome
- Drainage rate 51 l/min

### OPTIONAL BASE FRAME

- Height-adjustable from 105 to 190 mm
- Sound-insulating
- Simple installation
- Can be adapted to different shower tray sizes

### OPTIONAL EXPANDING FOAM

### OPTIONAL SELF-ADHESIVE SEALING TAPE





## 31 MODELS x 2 RIM HEIGHTS x 2 FINISHES = A CHOICE OF 124 OPTIONS

|        |         | WIDTH  |        |        |        |         |
|--------|---------|--------|--------|--------|--------|---------|
|        |         | 700 mm | 750 mm | 800 mm | 900 mm | 1000 mm |
| LENGTH | 800 mm  |        |        | ✓      |        |         |
|        | 900 mm  | ✓      | ✓      | ✓      | ✓      |         |
|        | 1000 mm | ✓      | ✓      | ✓      | ✓      | ✓       |
|        | 1200 mm | ✓      | ✓      | ✓      | ✓      |         |
|        | 1400 mm | ✓      | ✓      | ✓      | ✓      |         |
|        | 1500 mm |        |        | ✓      | ✓      | ✓       |
|        | 1600 mm | ✓      | ✓      | ✓      | ✓      |         |
|        | 1700 mm | ✓      | ✓      | ✓      | ✓      |         |
|        | 1800 mm |        |        | ✓      | ✓      |         |



# VILLEROY & BOCH

Villeroy & Boch (UK) Limited  
Bathroom, Wellness and Tiles Division  
267 Merton Road  
London SW 18 5JS

Tel. +44 208 871 40 28  
Fax +44 208 870 37 20

Your contact:

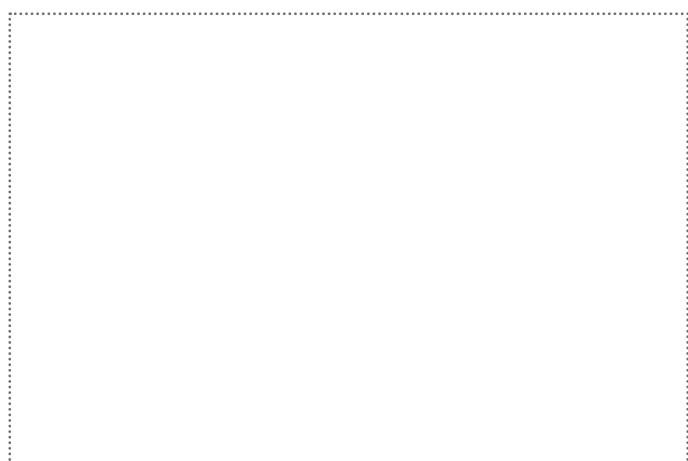

## **DF10001**

Variations in colour and dimensions comply with the customary tolerances.  
We reserve the right to alter the product range, to modify models and to change colours.

[PRO.VILLEROY-BOCH.COM/METALRIM](http://PRO.VILLEROY-BOCH.COM/METALRIM)

# ARCHITECTURA METALRIM

## Ultra-flat design, extra-high stability

Innovative MetalRim technology is used in the new generation of shower trays: it is a galvanised steel reinforcement that is integrated in all four edge areas and that ensures maximum material stability. The shower trays also allow ultimate flexibility thanks to 3 installation options.

### Proven material quality

- + High-quality sanitary acrylic with a 10-year guarantee, tested in acc. with standard EN 249
- + Maximum robustness tested up to 1000 kg
- + Non-porous, sealed surface for easy-cleaning and high gloss and therefore particularly hygienic
- + UV-resistant surface that can be repaired

### Minimalist design

- + Ultra-flat, rimless look
- + Flush-integrated water outlet cover

### Maximum safety

- + VilboGrip anti-slip finish, class C, available as an option
- + Level entry possible

### Easy and safe installation

- + 3 installation variants for maximum flexibility: flush-fit installation, installation on tiles, installation on a base
- + Easy standard assembly
- + Installation set available
- + MEPA Aquaproof sealing sets for corner and flush-fit installation of shower trays (48 mm) available

### Wide choice of models and colours

- + 31 models x 2 rim heights (15 mm and 48 mm) x 2 finishes = 124 possibilities
- + 7 colours: 01, 96, 1S, 2S, 3S, 4S, RW
- + Outlet cover available in matching colours including matt



## ACCESSORIES ACCESSORIES

### PRODUCT INFORMATION

#### 1. POSITION

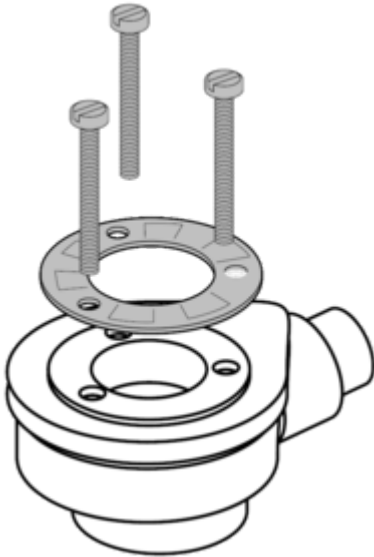

|                       |   |
|-----------------------|---|
| <b>Article number</b> | <b>U90881299</b>  |
| Article title         | Villeroy & Boch Accessories<br>Tempoplex Plus outlet, 140 x 270 x<br>140 mm |
| Product designation   | Tempoplex Plus outlet   |
| Collection            | Accessories   |
| PROJECTS              | ■ START   |
| Scope of delivery     | 1 x outlet  |
| Length in mm          | 270   |
| Width in mm           | 140   |
| Height in mm          | 140   |
| Weight in kg          | 0,32  |
| EAN number            | 4051202314095   |



## ACCESSORIES ACCESSORIES

### PRODUCT INFORMATION

#### 1. POSITION



|                       |   |
|-----------------------|---|
| <b>Article number</b> | <b>U82990000</b>  |
| Article title         | Villeroy & Boch Accessories Shower tray feet, 140 x 650 x 72 mm |
| Product designation   | Shower tray feet  |
| Collection            | Accessories   |
| PROJECTS              | <span style="color: orange;">■</span> START                     |
| Scope of delivery     | 1 x shower tray feet  |
| Length in mm          | 650   |
| Width in mm           | 140   |
| Height in mm          | 72  |
| Weight in kg          | 1,88  |
| EAN number            | 8712335294284   |



# LEISTUNGSERKLÄRUNG

Sprache DE  
Original

N3213-01

(Artikelnummer siehe Liste im Anhang)  
Duschwannen; Material: Gelcoat, Acryl oder  
Quaryl

## 1. Eindeutiger Kenncode des Produkttyps

Die Liste der Produkte befindet sich im Anhang.

## 2. Verwendungszweck(e)

persönliche Hygiene

## 3. Hersteller

Villeroy & Boch AG  
Saaruferstraße  
66693 Mettlach  
Deutschland

+49 (0) 68 64 / 8 10

[information@villeroy-boch.com](mailto:information@villeroy-boch.com)

[www.villeroy-boch.com](http://www.villeroy-boch.com)

## 4. Bevollmächtigter

Nicht anwendbar

## 5. System(e) zur Bewertung und Überprüfung der Leistungsbeständigkeit

Der Leistungsnachweis erfolgt nach System 4.

## 6. Harmonisierte Norm & 7. Erklärte Leistung(en)

Notifizierte Stelle(n) - Nicht anwendbar

| Wesentliche Merkmale | Leistung  | Harmonisierte Norm    |
|----------------------|-----------|-----------------------|
| Reinigbarkeit (CA)   | bestanden | EN 14527:2006+A1:2010 |
| Dauerhaftigkeit (DA) | bestanden | EN 14527:2006+A1:2010 |

Die Leistung des Produkts entspricht der erklärten Leistung/den erklärten Leistungen. Für die Erstellung der Leistungserklärung im Einklang mit der Verordnung (EU) Nr. 305/2011 ist allein der oben genannte Hersteller verantwortlich.

Unterzeichnet für den Hersteller und im Namen des Herstellers von:

Mettlach, 13.11.2023

Ort und Datum

Unterschrift

Georg Lörz  
Mitglied der Geschäftsführung  
Leiter des Unternehmensbereichs Bad und  
Wellness

Unterschrift

ppa Giovanni Gattone  
Technischer Direktor/Head of Manufacturing

# PROHLÁŠENÍ O VLASTNOSTECH

Jazyk CS  
Překlad

N3213-01

(Objednací číslo výrobku, viz seznam v příloze)  
Sprchové vaničky; materiál: Gelcoat, akryl nebo  
Quaryl

## 1. Jedinečný identifikační kód typu výrobku

Seznam výrobků příložen.

## 2. Zamýšlené/zamýšlená použití:

Osobní hygiena

## 3. Výrobce

Villeroy & Boch AG  
Saaruferstraße  
66693 Mettlach  
Německo

+49 (0) 68 64 / 8 10

[information@villeroy-boch.com](mailto:information@villeroy-boch.com)

[www.villeroy-boch.com](http://www.villeroy-boch.com)

## 4. Zplnomocněný zástupce:

netýká se

## 5. Systém/systémy POSV

Prohlášení o vlastnostech se vydává ve smyslu systému č. 4.

## 6. Harmonizovaná norma & 7. Deklarovaná vlastnost/Deklarované vlastnosti

Oznámené subjekt - netýká se

| Základní vlastnosti | Funkční vlastnosti | Harmonizovaná norma   |
|---------------------|--------------------|-----------------------|
| Čistitelnost (CA)   | Vyhovuje           | EN 14527:2006+A1:2010 |
| Životnost (DA)      | Vyhovuje           | EN 14527:2006+A1:2010 |

Vlastnosti výše uvedeného výrobku jsou ve shodě se souborem deklarovaných vlastností. Toto prohlášení o vlastnostech se v souladu s nařízením (EU) č. 305/2011 vydává na výhradní odpovědnost výrobce uvedeného výše.

Podepsáno za výrobce a jeho jménem:

Mettlach, 13.11.2023

Místo a datum

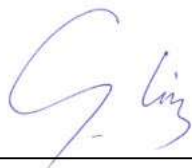

Podpis

Georg Lörz  
Člen vedení společnosti  
vedoucí divize Koupelny a wellness

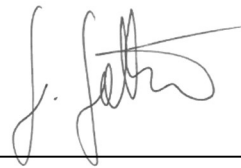

Podpis

ppa Giovanni Gattone  
Technický ředitel/Head of Manufacturing



# DECLARATION OF PERFORMANCE

Language EN-GB  
Translation

|   |
|---|
| <b>N3213-01</b>   |
| (Item number: see list in Appendix)<br>Shower trays; material: Gelcoat, Acrylic or Quaryl |

**1. Unique identification code of the product-type**  
The list of products can be found in the Appendix

**2. Intended use/es**  
Personal Hygiene

**3. Manufacturer**

Villeroy & Boch AG  
Saaruferstraße  
66693 Mettlach  
Germany

+49 (0) 68 64 / 8 10  
[information@villeroy-boch.com](mailto:information@villeroy-boch.com)  
[www.villeroy-boch.com](http://www.villeroy-boch.com)

**4. Authorised Representative**  
Not applicable

**5. System/s of AVCP**  
The certificate of performance is awarded pursuant to System 4.

**6. Harmonized Standard & 7. Declared Performance**

Notified body/ies - Not applicable

| Essential Characteristics | Performance | Harmonized standard   |
|---------------------------|-------------|-----------------------|
| Cleanability (CA)         | passed      | EN 14527:2006+A1:2010 |
| Durability (DA)           | passed      | EN 14527:2006+A1:2010 |

The performance of the product identified above is in conformity with the set of declared performance/s. This declaration of performance is issued, in accordance with Regulation (EU) No 305/2011, under the sole responsibility of the manufacturer identified above.

Signed for and on behalf of the manufacturer by:

Mettlach, 13.11.2023

Place and date

Signature

Georg Lörz  
Member of the Management Board  
Head of Bathroom and Wellness Division

Signature

ppa Giovanni Gattone  
Technical Director/Head of Manufacturing

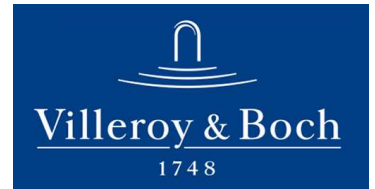

# DECLARATION OF PERFORMANCE

Language EN-GB\_UK  
Translation

N3213-01

(Item number: see list in Appendix)  
Shower trays; material: Gelcoat, Acrylic or Quarryl

**1. Unique identification code of the product-type**  
The list of products can be found in the Appendix

**2. Intended use/es**  
Personal Hygiene

**3. Manufacturer**

Villeroy & Boch AG  
Saaruferstraße  
66693 Mettlach  
Germany

+49 (0) 68 64 / 8 10  
[information@villeroy-boch.com](mailto:information@villeroy-boch.com)  
[www.villeroy-boch.com](http://www.villeroy-boch.com)

**4. Authorised Representative**  
Not applicable

**5. System/s of AVCP**  
The certificate of performance is awarded pursuant to System 4.

**6. Harmonized Standard & 7. Declared Performance**

Notified body/ies - Not applicable

| Key features      | Performance | Harmonized standard   |
|-------------------|-------------|-----------------------|
| Cleanability (CA) | passed      | EN 14527:2006+A1:2010 |
| Durability (DA)   | passed      | EN 14527:2006+A1:2010 |

The performance of the product identified above is in conformity with the set of declared performance/s. This declaration of performance is issued, in accordance with 465/2019 (UK) exiting the European Union building and building construction market standards, under the sole responsibility of the manufacturer identified above.

Signed for and on behalf of the manufacturer by:

Mettlach, 13.11.2023

Place and date

Signature

Georg Lörz  
Member of the Management Board  
Head of Bathroom and Wellness Division

Signature

ppa Giovanni Gattone  
Technical Director/Head of Manufacturing

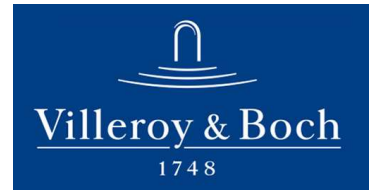

# DÉCLARATION DES PERFORMANCES

Langue FR  
Traduction

N3213-01

Références des articles : voir la liste en annexe)  
Receveurs de douche ; matériau : Gelcoat,  
Acrylique ou Quaryl®

**1. Code d'identification unique du produit type**  
La liste des produits se trouve en annexe.

**2. Usage(s) prévu(s)**  
Hygiène corporelle

**3. Fabricant**

Villeroy & Boch AG  
Saaruferstraße  
66693 Mettlach  
Allemagne

+49 (0) 68 64 / 8 10  
[information@villeroy-boch.com](mailto:information@villeroy-boch.com)  
[www.villeroy-boch.com](http://www.villeroy-boch.com)

**4. Mandataire**  
Sans objet

**5. Système(s) d'évaluation et de vérification de la constance des performances**  
L'attestation de performance est effectuée selon le système 4

**6. Norme harmonisée & 7. Performance(s) d'éclairée(s)**

**Organisme(s) notifié(s)** - Sans objet

| caractéristique essentielle | Performance         | Norme harmonisée      |
|-----------------------------|---------------------|-----------------------|
| Nettoyabilité (CA)          | exigance satisfaite | EN 14527:2006+A1:2010 |
| Longévité (DA)              | exigance satisfaite | EN 14527:2006+A1:2010 |

Les performances du produit identifié ci-dessus sont conformes aux performances déclarées. Conformément au règlement (UE) no 305/2011, la présente déclaration des performances est établie sous la seule responsabilité du fabricant mentionné ci-dessus.

Signé pour le fabricant et en son nom par:

Mettlach, 13.11.2023

Lieu et date

Signature

Georg Lörz  
Membres de la direction  
Directeur de la division Salle de bains et  
Wellness

Signature

ppa Giovanni Gattone  
Directeur technique/Head of Manufacturing

# TELJESÍTMÉNY NYILATKOZAT

Nyelv HU  
Fordítás

N3213-01

(A cikkszámokat lásd a függelékben található listában)  
Zuhanytálcák; Anyaga: Gelcoat, Akril vagy Quaril

## 1. A terméktípus egyedi azonosító kódja

A termékek listája a függelékben található.

## 2. Felhasználás célja(i)

Testi higiénia

## 3. Gyártó

Villeroy & Boch AG  
Saaruferstraße  
66693 Mettlach  
Németország

+49 (0) 68 64 / 8 10

[information@villeroy-boch.com](mailto:information@villeroy-boch.com)

[www.villeroy-boch.com](http://www.villeroy-boch.com)

## 4. A meghatalmazott képviselő

Nem alkalmazható

## 5. Az AVCP-rendszer(ek)

A teljesítmény igazolása a 4-es rendszer szerint történik.

## 6. Harmonizált szabvány & 7. A nyilatkozatban szereplő teljesítmény(ek)

Bejelentett szerv(ek) - Nem alkalmazható

| Döntő jellemzők     | Teljesítmény | Harmonizált szabvány  |
|---------------------|--------------|-----------------------|
| Tisztíthatóság (CA) | megfelelt    | EN 14527:2006+A1:2010 |
| Élettartam (DA)     | megfelelt    | EN 14527:2006+A1:2010 |

A fent azonosított termék teljesítménye megfelel a bejelentett teljesítmény(ek)nek. A 305/2011/EU rendeletnek megfelelően e teljesítménynyilatkozat kiadásáért kizárólag a fent meghatározott gyártó a felelős.

A gyártó nevében és részéről aláíró személy:

Mettlach, 13.11.2023

Hely és dátum

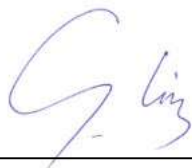

Aláírás

Georg Lörz  
A menedzsment tagja  
A Fürdőszoba és Wellness részleg vezetője

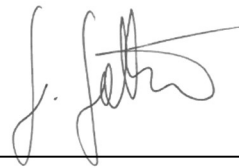

Aláírás

ppa Giovanni Gattone  
Műszaki igazgató/Gyártásvezető

# DICHIARAZIONE DI PRESTAZIONE

Lingua IT  
Traduzione

N3213-01

(Per i codici articolo si veda la lista nell'allegato)  
Piatti doccia; materiale: Gelcoat, acrilato o Quaryl

## 1. Codice di identificazione unico del prodotto-tipo

La lista dei prodotti è riportata nell'allegato.

## 2. Usi previsti

Lavelli da cucina

## 3. Fabbricante

Villeroy & Boch AG  
Saaruferstraße  
66693 Mettlach  
Germania

+49 (0) 68 64 / 8 10

[information@villeroy-boch.com](mailto:information@villeroy-boch.com)

[www.villeroy-boch.com](http://www.villeroy-boch.com)

## 4. Mandatorio

non applicabile

## 5. Sistemi di VVCP

La prestazione viene comprovata secondo il Sistema 4.

## 6. Norma armonizzata & 7. Prestazioni dichiarate

Organismi notificati - non applicabile

| caratteristica elencata | Prestazione | Norma armonizzata     |
|-------------------------|-------------|-----------------------|
| Pulibilità (CA)         | superata    | EN 14527:2006+A1:2010 |
| Durata utile (DA)       | superata    | EN 14527:2006+A1:2010 |

La prestazione del prodotto sopra identificato è conforme all'insieme delle prestazioni dichiarate. La presente dichiarazione di responsabilità viene emessa, in conformità al regolamento (UE) n. 305/2011, sotto la sola responsabilità del fabbricante sopra identificato.

Firmato a nome e per conto di:

Mettlach, 13.11.2023

Luogo e data

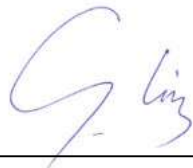

Firma

Georg Lörz  
Membro della Direzione  
Responsabile del settore Bagno e Wellness



Firma

ppa Giovanni Gattone  
Direttore tecnico/Head of Manufacturing



# PRESTATIEVERKLARING

Taal NL  
Vertaling

N3213-01

(Artikelnummer zie lijst in de bijlage)  
Douchebakken; Materiaal: Gelcoat, acryl of Quaryl

**1. Unieke identificatiecode van het producttype**  
De lijst met producten bevindt zich in de bijlage.

**2. Beoogd(e) gebruik(en)**  
Lichaamshygiëne

**3. Fabrikant**

Villeroy & Boch AG  
Saaruferstraße  
66693 Mettlach  
Duitsland

+49 (0) 68 64 / 8 10  
[information@villeroy-boch.com](mailto:information@villeroy-boch.com)  
[www.villeroy-boch.com](http://www.villeroy-boch.com)

**4. Gemachtigde**  
niet toepasbaar

**5. Het systeem of de systemen voor de beoordeling en verificatie van de prestatiebestendigheid**  
Het bewijs voor de geleverde prestatie wordt aangetoond door systeem 4.

**6. Geharmoniseerde norm & 7. Aangegeven prestatie(s)**

Aangemelde instantie(s) - niet toepasbaar

| essentieel kenmerk   | prestatie      | Geharmoniseerde norm  |
|----------------------|----------------|-----------------------|
| Schoonmaakgemak (CA) | test doorstaan | EN 14527:2006+A1:2010 |
| Levensduur (DA)      | test doorstaan | EN 14527:2006+A1:2010 |

De prestaties van het hierboven omschreven product zijn conform de aangegeven prestaties. Deze prestatieverklaring wordt in overeenstemming met Verordening (EU) nr. 305/2011 onder de exclusieve verantwoordelijkheid van de hierboven vermelde fabrikant verstrekt.

Ondertekend voor en namens de fabrikant door:

Mettlach, 13.11.2023

Plaats en datum

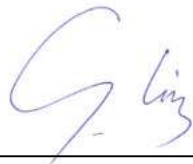

Handtekening

Georg Lörz  
Lid van de raad van bestuur  
Hoofd van de afdeling Badkamer en Wellness

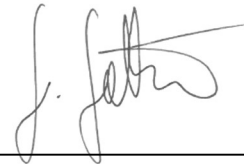

Handtekening

ppa Giovanni Gattone  
Technisch directeur/Head of Manufacturing



# DEKLARACJA WŁAŚCIWOŚCI UŻYTKOWYCH

Język PL  
Tłumaczenie

N3213-01

(Numer artykułu znajduje się na liście w załączniku)  
Brodziki; materiał: Gelcoat, akryl lub Kwaryl

## 1. Niepowtarzalny kod identyfikacyjny typu wyrobu

Lista wyrobów znajduje się w załączniku.

## 2. Zamierzone zastosowanie lub zastosowania

Higiena osobista.

## 3. Producent

Villeroy & Boch AG  
Saaruferstraße  
66693 Mettlach  
Niemcy

+49 (0) 68 64 / 8 10

[information@villeroy-boch.com](mailto:information@villeroy-boch.com)

[www.villeroy-boch.com](http://www.villeroy-boch.com)

## 4. Upoważniony przedstawiciel

nie dotyczy

## 5. System(-y) oceny i weryfikacji stałości właściwości użytkowych

Ocena i weryfikacja stałości właściwości użytkowych według systemu 4

## 6. Norma zharmonizowana & 7. Deklarowane właściwości użytkowe

Jednostka lub jednostki notyfikowane: - nie dotyczy

| charakterystyk określonych   | Właściwość użytkowa | Norma zharmonizowana  |
|------------------------------|---------------------|-----------------------|
| Zdolność do czyszczenia (CA) | spełnia             | EN 14527:2006+A1:2010 |
| Trwałość (DA)                | spełnia             | EN 14527:2006+A1:2010 |

Właściwości użytkowe określonego powyżej wyrobu są zgodne z zestawem deklarowanych właściwości użytkowych. Niniejsza deklaracja właściwości użytkowych wydana zostaje zgodnie z rozporządzeniem (UE) nr 305/2011 na wyłączną odpowiedzialność producenta określonego powyżej.

W imieniu producenta podpisał:

Mettlach, 13.11.2023

Miejsce i data

Podpis

Georg Lörz  
Członek dyrekcji  
Kierownik działu Łazienka i wellness

Podpis

ppa Giovanni Gattone  
Dyrektor techniczny / Head of Manufacturing

# VYHLÁSENIE O VLASTNOSTIACH

Jazyk SK  
Preklad

N3213-01

(Objednávacie číslo výrobku, viď zoznam v prílohe)  
Sprchovacie vaničky; materiál: Gelcoat, akryl alebo  
Quaryl

**1. Jedinečný identifikačný kód typu výrobku**  
Zoznam výrobkov je uvedený v prílohe.

**2. Zamýšľané použitie/použitia**  
Osobná hygiena

**3. Výrobca**

Villeroy & Boch AG  
Saaruferstraße  
66693 Mettlach  
Nemecko

+49 (0) 68 64 / 8 10  
[information@villeroy-boch.com](mailto:information@villeroy-boch.com)  
[www.villeroy-boch.com](http://www.villeroy-boch.com)

**4. Splnomocnený zástupca**  
neuplatňuje sa

**5. Systém(-y) posudzovania a overovania nemennosti parametrov**  
Vyhlásenie o vlastnostiach sa vydáva v zmysle systému č. 4.

**6. Harmonizovaná norma & 7. Deklarované parametre**

Notifikovaný(-é) subjekt(-y) - neuplatňuje sa

| podstatných vlastností | parametre | Harmonizovaná norma   |
|------------------------|-----------|-----------------------|
| Čistiteľnosť (CA)      | Vyhovuje  | EN 14527:2006+A1:2010 |
| Životnosť (DA)         | Vyhovuje  | EN 14527:2006+A1:2010 |

Uvedené parametre výrobku sú v zhode so súborom deklarováných parametrov. Toto vyhlásenie o parametroch sa v súlade nariadenin (EÚ) c. 305/2011 vydáva na výhradnú zodpovednosť uvedeného výrobcu

Podpísal za a v mene výrobcu

Mettlach, 13.11.2023

Miesto a dátum

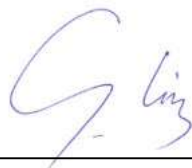

Podpis

Georg Lörz  
Člen vedenia spoločnosti  
Riaditeľ úseku Kúpeľne a wellness

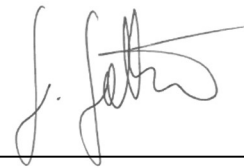

Podpis

ppa Giovanni Gattone  
Technický riaditeľ/Head of Manufacturing

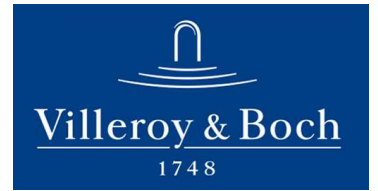

# DECLARACIÓN DE RENDIMIENTO

Lengua ES  
Traducción

N3213-01

(Ver referencia en la lista adjunta)  
Platos de ducha; material: Gelcoat, acrílico o  
Quaryl

**1. Código de identificación única del producto tipo**  
Se adjunta lista de productos.

**2. Usos previstos**  
Higiene corporal

**3. Fabricante**

Villeroy & Boch AG  
Saaruferstraße  
66693 Mettlach  
Alemania

+49 (0) 68 64 / 8 10  
[information@villeroy-boch.com](mailto:information@villeroy-boch.com)  
[www.villeroy-boch.com](http://www.villeroy-boch.com)

**4. Representante autorizado**  
ei kohaldata

**5. Sistemas de evaluación y verificación de la constancia de las prestaciones (EVSP)**  
Certificado de rendimiento según sistema 4.

**6. Norma armonizada & 7. Prestaciones declaradas**

**Organismos notificados** - ei kohaldata

| características esenciales | Prestaciones | Norma armonizada      |
|----------------------------|--------------|-----------------------|
| Facilidad de limpieza (CA) | suficiente   | EN 14527:2006+A1:2010 |
| Durabilidad (DA)           | suficiente   | EN 14527:2006+A1:2010 |

Las prestaciones del producto identificado anteriormente son conformes con el conjunto de prestaciones declaradas. La presente declaración de prestaciones se emite, de conformidad con el Reglamento (UE) no 305/2011, bajo la sola responsabilidad del fabricante arriba identificado.

Firmado por y en nombre del fabricante por:

Mettlach, 13.11.2023

Lugar y fecha

Firma

Georg Lörz  
Miembro de la dirección  
Director de la División Baño y Wellness

Firma

ppa Giovanni Gattone  
Director técnico/Head of Manufacturing

## ДЕКЛАРАЦИЯ ЗА ЕКСПЛОАТАЦИОННИ ПОКАЗАТЕЛИ

език BG  
Превод

N3213-01

(за номера на артикула вижте списъка в  
приложението)  
Поддушови корита; материал: Гелкоат, Акрил  
или кварил

### 1. Уникален идентификационен код на типа продукт

Списъкът с продукти може да бъде намерен в приложението.

### 2. Предвидена употреба/употреби

лична хигиена

### 3. Производител

Villeroy & Boch AG  
Saaruferstraße  
66693 Mettlach  
Германия

+49 (0) 68 64 / 8 10  
[information@villeroy-boch.com](mailto:information@villeroy-boch.com)  
[www.villeroy-boch.com](http://www.villeroy-boch.com)

### 4. Упълномощен представител

неприложимо

### 5. Система/системи за оценяване и проверка на постоянството на експлоатационните показатели

Доказването на експлоатационните показатели се извършва съгласно система 4.

### 6. Хармонизиран стандарт & 7. Декларираните експлоатационни показатели

Нотифициран орган/органи - неприложимо

| Съществени характеристики     | Показател | Хармонизиран стандарт |
|-------------------------------|-----------|-----------------------|
| Възможност за почистване (CA) | покрито   | EN 14527:2006+A1:2010 |
| Трайност (DA)                 | покрито   | EN 14527:2006+A1:2010 |

Експлоатационните показатели на продукта съответстват на декларираните експлоатационни показатели. Посоченият по-горе производител е единствено отговорен за изготвянето на декларацията за експлоатационни показатели в съответствие с Регламент (ЕС) № 305/2011.

Подписано за и от името на производителя от:

Mettlach, 13.11.2023

Място и дата

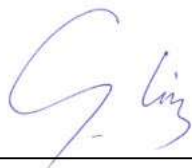

Подпис

Georg Lörz  
Член на управителния съвет  
Ръководител на бизнес направление „Баня  
и уелнес“

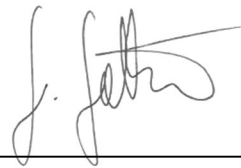

Подпис

ppa Giovanni Gattone  
Технически директор/ръководител  
производство



# YDEEVNEDEKLARATION

Sprog DA  
Oversættelse

N3213-01

(Artikelnummer se vedlagte liste)  
Badekar; Materiale: Gelcoat, Akryl eller Quaryl

## 1. Varetypens unikke identifikationskode

Listen over produkter er vedlagt.

## 2. Tilsigtet anvendelse:

Personlig hygiejne

## 3. Fabrikant

Villeroy & Boch AG  
Saaruferstraße  
66693 Mettlach  
Tyskland

+49 (0) 68 64 / 8 10

[information@villeroy-boch.com](mailto:information@villeroy-boch.com)

[www.villeroy-boch.com](http://www.villeroy-boch.com)

## 4. Bemyndiget repræsentant

ikke relevant

## 5. System eller systemer til vurdering og kontrol af konstansen af ydeevnen

Dokumentation for ydeevne sker iht. System 4.

## 6. Harmoniseret standard & 7. Deklareret ydeevne/deklarerede ydeevner

Notificeret organ/notificerede organer - ikke relevant

| væsentlige egenskaber    | Ydeevne | Harmoniseret standard |
|--------------------------|---------|-----------------------|
| Rengøring (CA)           | bestået | EN 14527:2006+A1:2010 |
| Belastningsmodstand (DA) | bestået | EN 14527:2006+A1:2010 |

Ydeevnen for den vare, der er anført ovenfor, er i overensstemmelse med den deklarerede ydeevne. Denne ydeevnedeklaration er udarbejdet i overensstemmelse med forordning (EU) nr. 305/2011 på eneansvar af den fabrikant, der er anført ovenfor.

Underskrevet for fabrikanten og på dennes vegne af:

Mettlach, 13.11.2023

Sted og dato

Underskrift

Georg Lörz  
Bestyrelsesmedlem  
Chef for virksomhedsområdet bad og wellness

Underskrift

ppa Giovanni Gattone  
Teknisk chef/Head of Manufacturing

# TOIMIVUSDEKLARATSIOON

Keel ET  
Tölge

N3213-01

(Toote number, vt lisas olevat loendit)  
Dušialused; materjal: Gelcoat, akrüül või Kvarüül

## 1. Tootetüübi kordumatu identifitseerimiskood

Toodete loend asub lisas.

## 2. Kavandatud kasutusala(d)

isiklik hügieen

## 3. Tootja

Villeroy & Boch AG  
Saarufstraße  
66693 Mettlach  
Saksamaa

+49 (0) 68 64 / 8 10

[information@villeroy-boch.com](mailto:information@villeroy-boch.com)

[www.villeroy-boch.com](http://www.villeroy-boch.com)

## 4. Volitatud esindaja

puudub

## 5. Toimivuse püsivuse hindamise ja kontrolli süsteem

Toimivustõend väljastatakse vastavalt süsteemile 4.

## 6. Ühtlustatud standard & 7. Deklareeritud toimivus

Teavitatud asutus(ed) - puudub

| põhiomaduste      | Toimivus | Ühtlustatud standard  |
|-------------------|----------|-----------------------|
| Puhtus (CA)       | korras   | EN 14527:2006+A1:2010 |
| Vastupidavus (DA) | korras   | EN 14527:2006+A1:2010 |

Toote toimivus vastab deklareeritud toimivusele / deklareeritud toimivustele. Toimivusdeklaratsiooni koostamise eest kooskõlas määrusega (EL) nr 305/2011 vastutab ainult ülalnimetatud tootja.

Tootja poolt ja nimel allkirjastanud:

Mettlach, 13.11.2023

Koht ja kuupäev

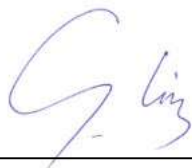

Allkiri

Georg Lörz  
Juhatuseliige  
Vannitoa ja heaolu valdkonna juhataja

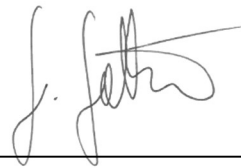

Allkiri

ppa Giovanni Gattone  
Tehniline juht / tootmisjuht



## ΔΗΛΩΣΗ ΕΠΙΔΟΣΕΩΝ

Γλώσσα EL  
Μετάφραση

N3213-01

(Αριθμός είδους βλέπε λίστα στο παράρτημα)  
Ντουζιέρες, υλικό: Ζελκόατ, ακρυλικό ή Quartz

### 1. Μοναδικός κωδικός ταυτοποίησης του τύπου του προϊόντος

Η λίστα των προϊόντων βρίσκεται στο παράρτημα.

### 2. Προβλεπόμενη (-ες) χρήση (-εις)

προσωπική υγιεινή

### 3. Κατασκευαστής

Villeroy & Boch AG  
Saaruferstraße  
66693 Mettlach  
Γερμανία

+49 (0) 68 64 / 8 10

[information@villeroy-boch.com](mailto:information@villeroy-boch.com)

[www.villeroy-boch.com](http://www.villeroy-boch.com)

### 4. Εξουσιοδοτημένος αντιπρόσωπος

δεν εφαρμόζεται

### 5. Σύστημα/συστήματα AVCP (αξιολόγηση και επαλήθευση της σταθερότητας της επίδοσης)

Η απόδειξη της επίδοσης πραγματοποιείται σύμφωνα με το σύστημα 4.

### 6. Εναρμονισμένα πρότυπα & 7. Δηλωθείσα(-ες) επίδοση(-εις)

Κοινοποιημένος(-οι) οργανισμός(-οι) - δεν εφαρμόζεται

| Σημαντικά χαρακτηριστικά   | Επίδοση  | Εναρμονισμένα πρότυπα |
|----------------------------|----------|-----------------------|
| Δυνατότητα καθαρισμού (CA) | επιτυχής | EN 14527:2006+A1:2010 |
| Ανθεκτικότητα (DA)         | επιτυχής | EN 14527:2006+A1:2010 |

Η επίδοση του προϊόντος είναι σύμφωνη με τη(τις) δηλωθείσα(-ες) επίδοση(-εις). Η δήλωση αυτή των επιδόσεων συντάσσεται, σύμφωνα με τον κανονισμό (ΕΕ) αριθ. 305/2011, με αποκλειστική ευθύνη του κατασκευαστή που ταυτοποιείται ανωτέρω.

Υπογραφή για λογαριασμό και εξ ονόματος του κατασκευαστή από:

Mettlach, 13.11.2023

Τόπος και

υπογραφή

Georg Lörz  
Μέλος της διοίκησης  
Διευθυντής του τμήματος λουτρών  
και Wellness

υπογραφή

ppa Giovanni Gattone  
Τεχνικός διευθυντής /Head of  
Manufacturing



# SUORITUSTASOILMOITUS

Kieli FI  
Käännös

N3213-01

(Tuotenumero, katso liitteen luettelo)  
Suihkualtaat; materiaali: Gelcoat, Akryyli tai Quaryl

## 1. Tuotetyypin yksilöllinen tunnistus

Luettelo tuotteista on liitteessä.

## 2. Aiottu käyttötarkoitus (aiotut käyttötarkoitukset)

henkilökohtainen hygienia

## 3. Valmistaja

Villeroy & Boch AG  
Saaruferrstraße  
66693 Mettlach  
Saksa

+49 (0) 68 64 / 8 10

[information@villeroy-boch.com](mailto:information@villeroy-boch.com)

[www.villeroy-boch.com](http://www.villeroy-boch.com)

## 4. Valtuutettu edustaja

ei sovellettavissa

## 5. Suoritusason pysyvyyden arvioinnissa ja varmentamisessa käytetty järjestelmä/käytetyt järjestelmät:

Suoritusasotodistus annetaan järjestelmän 4 mukaisesti.

## 6. Yhdenmukaistettu standardi & 7. Ilmoitettu suoritusaso / ilmoitetut suoritusasot

Ilmoitettu laitos/ilmoitetut laitokset: - ei sovellettavissa

| Keskeiset ominaisuudet | Suoritusaso | Yhdenmukaistettu standardi |
|------------------------|-------------|----------------------------|
| Puhdistettavuus (CA)   | hyväksytty  | EN 14527:2006+A1:2010      |
| Kestävyys (DA)         | hyväksytty  | EN 14527:2006+A1:2010      |

Tuotteen suoritusaso vastaa ilmoitettua suoritusasoa / ilmoitettuja suoritusasioja. Suoritusasoilmoituksen laatimisesta on asetuksen (EU) nro 305/2011 mukaisesti yllämainittu valmistaja yksin vastuussa.

Valmistajan puolesta allekirjoittanut:

Mettlach, 13.11.2023

Paikka ja aika

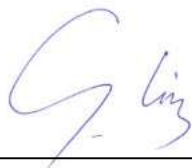

Allekirjoitus

Georg Lörz  
Yritysjohdon jäsen  
Kylpyhuone- ja wellness-osaston johtaja

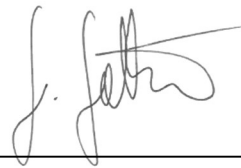

Allekirjoitus

ppa Giovanni Gattone  
Tekninen johtaja/Head of Manufacturing



# IZJAVA O SVOJSTVIMA

Jezik HR  
Prijevod

N3213-01

(za broj artikla vidi popis u prilogu)  
Tuš kade; materijal: Gelcoat, Akril ili Kvaril

**1. Jedinствена identifikacijska oznaka vrste proizvoda**  
Popis proizvoda nalazi se u prilogu.

**2. Namjena/namjene**  
osobna higijena

**3. Proizvođač**

Villeroy & Boch AG  
Saaruferstraße  
66693 Mettlach  
Njemačka

+49 (0) 68 64 / 8 10  
[information@villeroy-boch.com](mailto:information@villeroy-boch.com)  
[www.villeroy-boch.com](http://www.villeroy-boch.com)

**4. Ovlašteni predstavnik**  
nije primjenjivo

**5. Sustav/sustavi za ocjenu i provjeru stalnosti svojstava (AVCP)**  
Dokaz o svojstvima temelji se na sustavu 4.

**6. Usklađena norma & 7. Objavljena svojstva**

Prijavljeno tijelo/prijavljena tijela - nije primjenjivo

| Ključne značajke        | Svojstvo    | Usklađena norma       |
|-------------------------|-------------|-----------------------|
| Mogućnost čišćenja (CA) | zadovoljeno | EN 14527:2006+A1:2010 |
| Trajnost (DA)           | zadovoljeno | EN 14527:2006+A1:2010 |

Prije utvrđeno svojstvo proizvoda u skladu je s objavljenim svojstvima. Ova izjava o svojstvima izdaje se, u skladu s Uredbom (EU) br. 305/2011, pod isključivom odgovornošću prethodno utvrđenog proizvođača.

Za proizvođača i u njegovo ime potpisao:

Mettlach, 13.11.2023

Mjesto i datum

Potpis

Georg Lörz  
Član Uprave  
Voditelj Odjela za kupaonice i wellness

Potpis

ppa Giovanni Gattone  
Tehnički direktor / voditelj proizvodnje



# EKSPLOATACINIŲ SAVYBIŲ DEKLARACIJA

Kalba LT  
Vertimas

N3213-01

(Gaminio numerį žr. priedo sąrašė)  
vonios, medžiaga: Gelcoat, Akrilas arba Kvarilas

## 1. Produkto tipo unikalus identifikavimo kodas

Gaminių sąrašas pateikiamas priede.

## 2. Naudojimo paskirtis (-ys)

asmens higiena

## 3. Gamintojas

Villeroy & Boch AG  
Saarferstraße  
66693 Mettlach  
Vokietija

+49 (0) 68 64 / 8 10

[information@villeroy-boch.com](mailto:information@villeroy-boch.com)

[www.villeroy-boch.com](http://www.villeroy-boch.com)

## 4. Įgaliotasis atstovas

nav piemērojams

## 5. Eksploatacinių savybių pastovumo vertinimo ir tikrinimo sistema (-os)

Eksploatacinės savybės patvirtinamos pagal 4 sistemą.

## 6. Darnusis standartas & Deklaruojama (-os) eksploatacinė (-ės) savybė (-ės)

Notifikuotoji (-osios) įstaiga (-os) - nav piemērojams

| Svarbiausi požymiai    | Eksploatacinė savybė | Darnusis standartas   |
|------------------------|----------------------|-----------------------|
| Švaros palaikymas (CA) | išlaikyta            | EN 14527:2006+A1:2010 |
| Ilgamžiškumas (DA)     | išlaikyta            | EN 14527:2006+A1:2010 |

Eksploatacinė gaminio savybė atitinka deklaruojamą eksploatacinę savybę / deklaruojamas eksploatacines savybes. Už eksploatacinių savybių deklaracijos parengimą pagal Reglamentą (ES) Nr. 305/2011 atsako tik pirmiau nurodytas gamintojas.

Pasirašyta (gamintojas ir jo vardu):

Mettlach, 13.11.2023

Vieta ir data

Parašas

Georg Lörz  
Vadovybės narys  
Vonios įrangos ir sveikatingumo skyriaus  
vadovas

Parašas

ppa Giovanni Gattone  
Techninis direktorius / Gamybos vadovas



# EKSPLUATĀCIJAS ĪPAŠĪBU DEKLARĀCIJA

Valoda LV  
Tulkojums

N3213-01

(Preces nr. skat pielikuma sarakstā)  
Dušas kabīnes; materiāls: Gelcoat, akrils vai Kvarils

## 1. Unikālais izstrādājuma tipa identifikācijas numurs

Produktu saraksts atrodams pielikumā.

## 2. Paredzētais izmantojums

Personiskā higiēna

## 3. Ražotājs

Villeroy & Boch AG  
Saarufenerstraße  
66693 Mettlach  
Vācija

+49 (0) 68 64 / 8 10  
[information@villeroy-boch.com](mailto:information@villeroy-boch.com)  
[www.villeroy-boch.com](http://www.villeroy-boch.com)

## 4. Pilnvarotais pārstāvis

netaikoma

## 5. Eksploatācijas īpašību noturības novērtējuma un pārbaudes (AVCP) sistēma(-as)

Eksploatācijas īpašību pierādīšana tiek veikta saskaņā ar 4. sistēmu.

## 6. Saskaņotais standarts & 7. Deklarētā(-ās) eksploatācijas īpašība(-as)

Paziņotā(-ās) iestāde(-es) - netaikoma

| Noteicošie rādītāji  | eksploatācijas īpašības | Saskaņotais standarts |
|----------------------|-------------------------|-----------------------|
| Tīrīšanas spēja (CA) | izturēts                | EN 14527:2006+A1:2010 |
| Izturība (DA)        | izturēts                | EN 14527:2006+A1:2010 |

Produkta eksploatācijas īpašības atbilst deklarētajām eksploatācijas īpašībām. Visu atbildību par snieguma deklarācijas sastādīšanu saskaņā ar Regulu (ES) Nr. 305/2011 uzņemas augstāk minētais ražotājs.

punktā norādītais ražotājs:

Mettlach, 13.11.2023

Vieta un datums

Paraksts

Georg Lörz  
Valdes loceklis  
Vannu un relaksācijas produktu nodaļas vadītājs

Paraksts

ppa Giovanni Gattone  
Tehniskais direktors / ražošanas vadītājs



# YTELSESERKLÆRING

Språk NO  
Oversettelse

N3213-01

(For artikkelnummer se liste i vedlegget)  
Dusjkar; materiale: Gelcoat, Akryl eller Quarryl

## 1. Entydig ID-kode for produkttypen

Listen over produktene finner du i vedlegget.

## 2. Bruksområde(r)

Personlig hygiene

## 3. Produsent

Villeroy & Boch AG  
Saaruferstraße  
66693 Mettlach  
Tyskland

+49 (0) 68 64 / 8 10

[information@villeroy-boch.com](mailto:information@villeroy-boch.com)

[www.villeroy-boch.com](http://www.villeroy-boch.com)

## 4. Agent

Ikke aktuelt

## 5. System(er) til vurdering og kontroll av ytelsesbestandighet

Ytelsessertifikatet utstedes etter system 4.

## 6. Harmonisert standard & 7. Erklært ytelse

Varslet organ/er - Ikke aktuelt

| Avgjørende kjennetegn  | Effekt  | Harmonisert standard  |
|------------------------|---------|-----------------------|
| Rengjøringsbarhet (CA) | bestått | EN 14527:2006+A1:2010 |
| Holdbarhet (DA)        | bestått | EN 14527:2006+A1:2010 |

Ytelsen til produktet samsvarer med den erklærte ytelsen/de erklærte ytelsene. For oppretting av ytelseserklæringen i overensstemmelse med forordning (EU) nr. 305/2011 er utelukkende produsenten ovenfor ansvarlig.

Signert for og på vegne av produsenten av:

Mettlach, 13.11.2023

Sted og dato:

Signatur

Georg Lörz  
Medlem i ledelsen  
Leder for forretningsområdet bad og Wellness

Signatur

ppa Giovanni Gattone  
Teknisk direktør/Head of Manufacturing

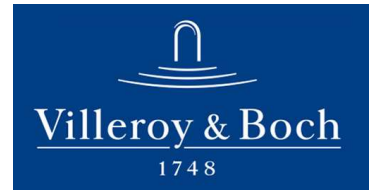

# DECLARAÇÃO DE DESEMPENHO

Língua PT  
Tradução

N3213-01

(Para o número de artigo, ver a lista no anexo)  
Bases de duche; material: Gelcoat, acrílico ou  
Quaryl

**1. Código de identificação único do produto-tipo**  
A lista dos produtos encontra-se no anexo.

**2. Utilização(ões) prevista(s)**  
higiene pessoal

**3. Fabricante**

Villeroy & Boch AG  
Saaruferstraße  
66693 Mettlach  
Alemanha

+49 (0) 68 64 / 8 10  
[information@villeroy-boch.com](mailto:information@villeroy-boch.com)  
[www.villeroy-boch.com](http://www.villeroy-boch.com)

**4. Mandatário**  
não se aplica

**5. Sistema(s) de avaliação e verificação da regularidade do desempenho (AVCP)**  
A verificação do desempenho é realizada de acordo com o sistema 4.

**6. Norma harmonizada & 7. Desempenho(s) declarado(s)**

**Organismo(s) notificado (s)** - não se aplica

| Características essenciais    | Desempenho | Norma harmonizada     |
|-------------------------------|------------|-----------------------|
| Possibilidade de limpeza (CA) | Aprovado   | EN 14527:2006+A1:2010 |
| Durabilidade (DA)             | Aprovado   | EN 14527:2006+A1:2010 |

O desempenho do produto está em conformidade com o conjunto de desempenhos declarados. A presente declaração de desempenho é emitida, em conformidade com o Regulamento (UE) n.º 305/2011, sob a exclusiva responsabilidade do fabricante identificado acima.

Assinado por e em nome do fabricante:

Mettlach, 13.11.2023

Local e data

Assinatura

Georg Lörz  
Membro do Conselho de Administração  
Chefe da Divisão Casa de Banho e Spa

Assinatura

ppa Giovanni Gattone  
Diretor Técnico/Head of Manufacturing



# DECLARAȚIE DE PERFORMANȚĂ

Limba RO  
Traducere

N3213-01

(Vezi lista din anexă pentru numărul articolului)  
Vane de duș; material: Gelcoat, acril sau Quaryl

## 1. Cod unic de identificare al produsului-tip

Lista de produse se află în anexă.

## 2. Utilizare (utilizări) preconizată (preconizate)

igienă personală

## 3. Fabricant

Villeroy & Boch AG  
Saaruferstraße  
66693 Mettlach  
Germania

+49 (0) 68 64 / 8 10

[information@villeroy-boch.com](mailto:information@villeroy-boch.com)

[www.villeroy-boch.com](http://www.villeroy-boch.com)

## 4. Reprezentant autorizat

nu se aplică

## 5. Sistemul (sistemele) de evaluare și de verificare a constanței performanței

Dovada performanței este realizată conform sistemului 4.

## 6. Standard armonizat & 7. Performanța (performanțe) declarată (declare)

Organism (organisme) notificat(e) - nu se aplică

| Caracteristică esențială | Performanță | Standard armonizat    |
|--------------------------|-------------|-----------------------|
| Curățare (CA)            | îndeplinit  | EN 14527:2006+A1:2010 |
| Durabilitate (DA)        | îndeplinit  | EN 14527:2006+A1:2010 |

Performanța produsului corespunde performanței/performanțelor declarate. Pentru întocmirea declarației de performanță în conformitate cu Regulamentul (UE) nr. 305/2011 este responsabil exclusiv producătorul menționat.

Semnată pentru și în numele fabricantului de către:

Mettlach, 13.11.2023

localitate și dată

Semnătură

Georg Lörz  
Membru al conducerii  
Directorul departamentului Baie și wellness

Semnătură

ppa Giovanni Gattone  
Director tehnic/Head of Manufacturing

# IZJAVA O LASTNOSTIH

Jezik SL  
Prevod

N3213-01

(Za številko izdelka glejte seznam v prilogi)  
Kadi za prhanje; material: Gelcoat, akril ali Kvaril

**1. Enotna identifikacijska oznaka tipa proizvoda**  
Seznam izdelkov je naveden v prilogi.

**2. Predvidena uporaba**  
osebna higiena

**3. Proizvajalec**

Villeroy & Boch AG  
Saaruferstraße  
66693 Mettlach  
Nemčija

+49 (0) 68 64 / 8 10  
[information@villeroy-boch.com](mailto:information@villeroy-boch.com)  
[www.villeroy-boch.com](http://www.villeroy-boch.com)

**4. Pooblaščen zastopnik**  
se ne uporablja

**5. Sistemi ocenjevanja in preverjanja nespremenljivosti lastnosti**  
Dokazilo o lastnostih je v skladu s sistemom 4.

**6. Harmonizirani standard & 7. Navedene lastnosti:**

**Priglašeni organi** - se ne uporablja

| Odločilne značilnosti | Lastnost   | Harmonizirani standard |
|-----------------------|------------|------------------------|
| Čistost (CA)          | opravljeno | EN 14527:2006+A1:2010  |
| Trajnost (DA)         | opravljeno | EN 14527:2006+A1:2010  |

Lastnost izdelka ustreza navedeni lastnosti/navedenim lastnostim. Za izdelavo izjave o lastnostih v skladu z Uredbo (EU) št. 305/2011 je odgovoren samo prej navedeni proizvajalec.

Podpisal za in v imenu proizvajalca:

Mettlach, 13.11.2023

Kraj in datum

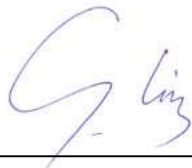

Podpis

Georg Lörz  
Član uprave  
Vodja oddelka za kopalnice in wellness



Podpis

ppa Giovanni Gattone  
Tehnični direktor/vodja proizvodnje





# PRESTANDEDEKLARATION

Språk SV  
Översättning

N3213-01

(Artikelnummer, se lista i bilagan)  
Duschkar, material: Gelcoat, Akryl eller Quaryl

## 1. Produkttypens unika identifikationskod

Listan över produkter finns i bilagan.

2. Avsedd användning/avsedda användningar  
personlig hygien

## 3. Tillverkare

Villeroy & Boch AG  
Saaruferstraße  
66693 Mettlach  
Tyskland

+49 (0) 68 64 / 8 10  
[information@villeroy-boch.com](mailto:information@villeroy-boch.com)  
[www.villeroy-boch.com](http://www.villeroy-boch.com)

## 4. Tillverkarens representant

inte tillämpligt

## 5. System för bedömning och fortlöpande kontroll av prestanda

Bevis om prestanda sker enligt system 4.

## 6. Harmoniserad standard & 7. Angiven prestanda

Anmält/ansömda organ - inte tillämpligt

| Utmärkande drag   | prestanda | Harmoniserad standard |
|-------------------|-----------|-----------------------|
| Rengörbarhet (CA) | uppfyller | EN 14527:2006+A1:2010 |
| Beständighet (DA) | uppfyller | EN 14527:2006+A1:2010 |

Prestandan för ovanstående produkt överensstämmer med den angivna prestandan. Denna prestandadeklaration har utfärdats i enlighet med förordning (EU) nr 305/2011 på eget ansvar av den tillverkare som anges ovan.

Undertecknat för tillverkaren av:

Mettlach, 13.11.2023

Ort och datum

Namnteckning

Georg Lörz  
Styrelseledamot  
Chef för divisionen bad och wellness

Namnteckning

ppa Giovanni Gattone  
Teknisk chef/Head of Manufacturing

# KAPASITE BEYANI

Dil TR  
Tercüme

N3213-01

(Ürün numarası için ekteki listeye bakınız)  
uş tekneleri, malzeme: Gelcoat, Akrilik veya Quaryl

**1. Ürün tipinin benzersiz tanım kodu**  
Ürünlerin listesi ektedir.

**2. Kullanım amacı (amaçları)**  
kişisel hijyen

**3. Üretici**

Villeroy & Boch AG  
Saaruferstraße  
66693 Mettlach  
Almanya

+49 (0) 68 64 / 8 10  
[information@villeroy-boch.com](mailto:information@villeroy-boch.com)  
[www.villeroy-boch.com](http://www.villeroy-boch.com)

**4. Temsilci**  
belirtilmiyor

**5. Kapasite dayanımının değerlendirilmesi ve kontrolü için sistem (sistemler)**  
Kapasite ispatı, Sistem 4'e göre gerçekleşir.

**6. Uyumlaştırılmış Standart ve 7. Beyan edilen kapasite (kapasiteler)**

**Onaylanmış kuruluş/kuruluşlar** - belirtilmiyor

| Belirleyici özellikler | Kapasite | Uyumlaştırılmış Standart |
|------------------------|----------|--------------------------|
| Temizlenebilirlik (CA) | geçti    | EN 14527:2006+A1:2010    |
| Dayanıklılık (DA)      | geçti    | EN 14527:2006+A1:2010    |

Ürünün kapasitesi, beyan edilen kapasiteye/kapasitelere uygundur. Kapasite beyanının 305/2011 sayılı düzenleme (AB) ile uyum için hazırlanmasından, tek başına yukarıda belirtilen üretici sorumludur.

Üretici adına ve adına imzalayan:

Mettlach, 13.11.2023

Yer ve tarih



İmza

Georg Lörz  
Yönetim kurulu üyesi  
Banyo ve Wellness bölümünün yöneticisi

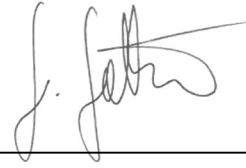

İmza

ppa Giovanni Gattone  
Teknik direktör/Üretim müdürü



## Appendix to the Declaration of Performance for N3213-01

|                |                       |                   |                       |
|----------------|-----------------------|-------------------|-----------------------|
| UDA1770ARA248V | ARCHITECTURA METALRIM | Shower tray Acryl | EN 14527:2006+A1:2010 |
| UDA1775ARA215V | ARCHITECTURA METALRIM | Shower tray Acryl | EN 14527:2006+A1:2010 |
| UDA1775ARA248V | ARCHITECTURA METALRIM | Shower tray Acryl | EN 14527:2006+A1:2010 |
| UDA1780ARA215V | ARCHITECTURA METALRIM | Shower tray Acryl | EN 14527:2006+A1:2010 |
| UDA1780ARA248V | ARCHITECTURA METALRIM | Shower tray Acryl | EN 14527:2006+A1:2010 |
| UDA1790ARA215V | ARCHITECTURA METALRIM | Shower tray Acryl | EN 14527:2006+A1:2010 |
| UDA1790ARA248V | ARCHITECTURA METALRIM | Shower tray Acryl | EN 14527:2006+A1:2010 |
| UDA1880ARA215V | ARCHITECTURA METALRIM | Shower tray Acryl | EN 14527:2006+A1:2010 |
| UDA1880ARA248V | ARCHITECTURA METALRIM | Shower tray Acryl | EN 14527:2006+A1:2010 |
| UDA1890ARA215V | ARCHITECTURA METALRIM | Shower tray Acryl | EN 14527:2006+A1:2010 |
| UDA1890ARA248V | ARCHITECTURA METALRIM | Shower tray Acryl | EN 14527:2006+A1:2010 |
| UDA8080ARA115V | ARCHITECTURA METALRIM | Shower tray Acryl | EN 14527:2006+A1:2010 |
| UDA8080ARA148V | ARCHITECTURA METALRIM | Shower tray Acryl | EN 14527:2006+A1:2010 |
| UDA9070ARA215V | ARCHITECTURA METALRIM | Shower tray Acryl | EN 14527:2006+A1:2010 |
| UDA9070ARA248V | ARCHITECTURA METALRIM | Shower tray Acryl | EN 14527:2006+A1:2010 |
| UDA9075ARA215V | ARCHITECTURA METALRIM | Shower tray Acryl | EN 14527:2006+A1:2010 |
| UDA9075ARA248V | ARCHITECTURA METALRIM | Shower tray Acryl | EN 14527:2006+A1:2010 |
| UDA9080ARA215V | ARCHITECTURA METALRIM | Shower tray Acryl | EN 14527:2006+A1:2010 |
| UDA9080ARA248V | ARCHITECTURA METALRIM | Shower tray Acryl | EN 14527:2006+A1:2010 |
| UDA9090ARA115V | ARCHITECTURA METALRIM | Shower tray Acryl | EN 14527:2006+A1:2010 |
| UDA9090ARA148V | ARCHITECTURA METALRIM | Shower tray Acryl | EN 14527:2006+A1:2010 |
| UDA1010EXC1V   | EXCELLO               | Shower tray Acryl | EN 14527:2006+A1:2010 |
| UDA1075EXC2V   | EXCELLO               | Shower tray Acryl | EN 14527:2006+A1:2010 |
| UDA1080EXC2V   | EXCELLO               | Shower tray Acryl | EN 14527:2006+A1:2010 |
| UDA1090EXC2V   | EXCELLO               | Shower tray Acryl | EN 14527:2006+A1:2010 |
| UDA1275EXC2V   | EXCELLO               | Shower tray Acryl | EN 14527:2006+A1:2010 |
| UDA1280EXC2V   | EXCELLO               | Shower tray Acryl | EN 14527:2006+A1:2010 |
| UDA1290EXC2V   | EXCELLO               | Shower tray Acryl | EN 14527:2006+A1:2010 |
| UDA1410EXC2V   | EXCELLO               | Shower tray Acryl | EN 14527:2006+A1:2010 |
| UDA1475EXC2V   | EXCELLO               | Shower tray Acryl | EN 14527:2006+A1:2010 |
| UDA1480EXC2V   | EXCELLO               | Shower tray Acryl | EN 14527:2006+A1:2010 |
| UDA1490EXC2V   | EXCELLO               | Shower tray Acryl | EN 14527:2006+A1:2010 |
| UDA1510EXC2V   | EXCELLO               | Shower tray Acryl | EN 14527:2006+A1:2010 |
| UDA1580EXC2V   | EXCELLO               | Shower tray Acryl | EN 14527:2006+A1:2010 |
| UDA1590EXC2V   | EXCELLO               | Shower tray Acryl | EN 14527:2006+A1:2010 |
| UDA1610EXC2V   | EXCELLO               | Shower tray Acryl | EN 14527:2006+A1:2010 |
| UDA1680EXC2V   | EXCELLO               | Shower tray Acryl | EN 14527:2006+A1:2010 |
| UDA1690EXC2V   | EXCELLO               | Shower tray Acryl | EN 14527:2006+A1:2010 |
| UDA1780EXC2V   | EXCELLO               | Shower tray Acryl | EN 14527:2006+A1:2010 |
| UDA1790EXC2V   | EXCELLO               | Shower tray Acryl | EN 14527:2006+A1:2010 |
| UDA1810EXC2V   | EXCELLO               | Shower tray Acryl | EN 14527:2006+A1:2010 |
| UDA1880EXC2V   | EXCELLO               | Shower tray Acryl | EN 14527:2006+A1:2010 |
| UDA1890EXC2V   | EXCELLO               | Shower tray Acryl | EN 14527:2006+A1:2010 |

Appendix to the Declaration of Performance for N3213-01

|               |          |                   |                       |
|---------------|----------|-------------------|-----------------------|
| UDA8080EXC1V  | EXCELLO  | Shower tray Acryl | EN 14527:2006+A1:2010 |
| UDA9075EXC2V  | EXCELLO  | Shower tray Acryl | EN 14527:2006+A1:2010 |
| UDA9080EXC2V  | EXCELLO  | Shower tray Acryl | EN 14527:2006+A1:2010 |
| UDA9090EXC1V  | EXCELLO  | Shower tray Acryl | EN 14527:2006+A1:2010 |
| UDA1010EXP1V  | EXKLUSIV | Shower tray Acryl | EN 14527:2006+A1:2010 |
| UDA1075EXP2V  | EXKLUSIV | Shower tray Acryl | EN 14527:2006+A1:2010 |
| UDA1080EXP2V  | EXKLUSIV | Shower tray Acryl | EN 14527:2006+A1:2010 |
| UDA1090EXP2V  | EXKLUSIV | Shower tray Acryl | EN 14527:2006+A1:2010 |
| UDA1275EXP2V  | EXKLUSIV | Shower tray Acryl | EN 14527:2006+A1:2010 |
| UDA1280EXP2V  | EXKLUSIV | Shower tray Acryl | EN 14527:2006+A1:2010 |
| UDA1290EXP2V  | EXKLUSIV | Shower tray Acryl | EN 14527:2006+A1:2010 |
| UDA1410EXP2V  | EXKLUSIV | Shower tray Acryl | EN 14527:2006+A1:2010 |
| UDA1475EXP2V  | EXKLUSIV | Shower tray Acryl | EN 14527:2006+A1:2010 |
| UDA1480EXP2V  | EXKLUSIV | Shower tray Acryl | EN 14527:2006+A1:2010 |
| UDA1490EXP2V  | EXKLUSIV | Shower tray Acryl | EN 14527:2006+A1:2010 |
| UDA1510EXP2V  | EXKLUSIV | Shower tray Acryl | EN 14527:2006+A1:2010 |
| UDA1580EXP2V  | EXKLUSIV | Shower tray Acryl | EN 14527:2006+A1:2010 |
| UDA1590EXP2V  | EXKLUSIV | Shower tray Acryl | EN 14527:2006+A1:2010 |
| UDA1610EXP2V  | EXKLUSIV | Shower tray Acryl | EN 14527:2006+A1:2010 |
| UDA1680EXP2V  | EXKLUSIV | Shower tray Acryl | EN 14527:2006+A1:2010 |
| UDA1690EXP2V  | EXKLUSIV | Shower tray Acryl | EN 14527:2006+A1:2010 |
| UDA1780EXP2V  | EXKLUSIV | Shower tray Acryl | EN 14527:2006+A1:2010 |
| UDA1790EXP2V  | EXKLUSIV | Shower tray Acryl | EN 14527:2006+A1:2010 |
| UDA1810EXP2V  | EXKLUSIV | Shower tray Acryl | EN 14527:2006+A1:2010 |
| UDA1880EXP2V  | EXKLUSIV | Shower tray Acryl | EN 14527:2006+A1:2010 |
| UDA1890EXP2V  | EXKLUSIV | Shower tray Acryl | EN 14527:2006+A1:2010 |
| UDA8080EXP1V  | EXKLUSIV | Shower tray Acryl | EN 14527:2006+A1:2010 |
| UDA9075EXP2V  | EXKLUSIV | Shower tray Acryl | EN 14527:2006+A1:2010 |
| UDA9080EXP2V  | EXKLUSIV | Shower tray Acryl | EN 14527:2006+A1:2010 |
| UDA9090EXP1V  | EXKLUSIV | Shower tray Acryl | EN 14527:2006+A1:2010 |
| UDA0806DEN1GV | O.NOVO   | Shower tray Acryl | EN 14527:2006+A1:2010 |
| UDA0806DEN1V  | O.NOVO   | Shower tray Acryl | EN 14527:2006+A1:2010 |
| UDA0906DEN1GV | O.NOVO   | Shower tray Acryl | EN 14527:2006+A1:2010 |
| UDA0906DEN1V  | O.NOVO   | Shower tray Acryl | EN 14527:2006+A1:2010 |
| UDA0906DEN4GV | O.NOVO   | Shower tray Acryl | EN 14527:2006+A1:2010 |
| UDA0906DEN4V  | O.NOVO   | Shower tray Acryl | EN 14527:2006+A1:2010 |
| UDA1006DEN1GV | O.NOVO   | Shower tray Acryl | EN 14527:2006+A1:2010 |
| UDA1006DEN1V  | O.NOVO   | Shower tray Acryl | EN 14527:2006+A1:2010 |
| UDA1006DEN4V  | O.NOVO   | Shower tray Acryl | EN 14527:2006+A1:2010 |
| UDA1006DEN5V  | O.NOVO   | Shower tray Acryl | EN 14527:2006+A1:2010 |
| UDA1296DEN2GV | O.NOVO   | Shower tray Acryl | EN 14527:2006+A1:2010 |
| UDA1296DEN2V  | O.NOVO   | Shower tray Acryl | EN 14527:2006+A1:2010 |
| UDA1806DEN2GV | O.NOVO   | Shower tray Acryl | EN 14527:2006+A1:2010 |

## Appendix to the Declaration of Performance for N3213-01

|                 |          |                     |                       |
|-----------------|----------|---------------------|-----------------------|
| UDA1806DEN2V    | O.NOVO   | Shower tray Acryl   | EN 14527:2006+A1:2010 |
| UDA9706DEN2V    | O.NOVO   | Shower tray Acryl   | EN 14527:2006+A1:2010 |
| UDA9806DEN2GV   | O.NOVO   | Shower tray Acryl   | EN 14527:2006+A1:2010 |
| UDA9806DEN2V    | O.NOVO   | Shower tray Acryl   | EN 14527:2006+A1:2010 |
| UDA1010PLA1V    | PLANEO   | Shower tray Acryl   | EN 14527:2006+A1:2010 |
| UDA1075PLA2V    | PLANEO   | Shower tray Acryl   | EN 14527:2006+A1:2010 |
| UDA1080PLA2V    | PLANEO   | Shower tray Acryl   | EN 14527:2006+A1:2010 |
| UDA1090PLA2V    | PLANEO   | Shower tray Acryl   | EN 14527:2006+A1:2010 |
| UDA1275PLA2V    | PLANEO   | Shower tray Acryl   | EN 14527:2006+A1:2010 |
| UDA1280PLA2V    | PLANEO   | Shower tray Acryl   | EN 14527:2006+A1:2010 |
| UDA1290PLA2V    | PLANEO   | Shower tray Acryl   | EN 14527:2006+A1:2010 |
| UDA1410PLA2V    | PLANEO   | Shower tray Acryl   | EN 14527:2006+A1:2010 |
| UDA1475PLA2V    | PLANEO   | Shower tray Acryl   | EN 14527:2006+A1:2010 |
| UDA1480PLA2V    | PLANEO   | Shower tray Acryl   | EN 14527:2006+A1:2010 |
| UDA1490PLA2V    | PLANEO   | Shower tray Acryl   | EN 14527:2006+A1:2010 |
| UDA1510PLA2V    | PLANEO   | Shower tray Acryl   | EN 14527:2006+A1:2010 |
| UDA1580PLA2V    | PLANEO   | Shower tray Acryl   | EN 14527:2006+A1:2010 |
| UDA1590PLA2V    | PLANEO   | Shower tray Acryl   | EN 14527:2006+A1:2010 |
| UDA1610PLA2V    | PLANEO   | Shower tray Acryl   | EN 14527:2006+A1:2010 |
| UDA1680PLA2V    | PLANEO   | Shower tray Acryl   | EN 14527:2006+A1:2010 |
| UDA1690PLA2V    | PLANEO   | Shower tray Acryl   | EN 14527:2006+A1:2010 |
| UDA1780PLA2V    | PLANEO   | Shower tray Acryl   | EN 14527:2006+A1:2010 |
| UDA1790PLA2V    | PLANEO   | Shower tray Acryl   | EN 14527:2006+A1:2010 |
| UDA1810PLA2V    | PLANEO   | Shower tray Acryl   | EN 14527:2006+A1:2010 |
| UDA1880PLA2V    | PLANEO   | Shower tray Acryl   | EN 14527:2006+A1:2010 |
| UDA1890PLA2V    | PLANEO   | Shower tray Acryl   | EN 14527:2006+A1:2010 |
| UDA8080PLA1V    | PLANEO   | Shower tray Acryl   | EN 14527:2006+A1:2010 |
| UDA9075PLA2V    | PLANEO   | Shower tray Acryl   | EN 14527:2006+A1:2010 |
| UDA9080PLA2V    | PLANEO   | Shower tray Acryl   | EN 14527:2006+A1:2010 |
| UDA9090PLA1V    | PLANEO   | Shower tray Acryl   | EN 14527:2006+A1:2010 |
| UDA0935SUB1V    | SUBWAY   | Shower tray Acryl   | EN 14527:2006+A1:2010 |
| UDA1035SUB1V    | SUBWAY   | Shower tray Acryl   | EN 14527:2006+A1:2010 |
| UDA1035SUB4V    | SUBWAY   | Shower tray Acryl   | EN 14527:2006+A1:2010 |
| UDA1293SUB2V    | SUBWAY   | Shower tray Acryl   | EN 14527:2006+A1:2010 |
| UDA1493SUB2V    | SUBWAY   | Shower tray Acryl   | EN 14527:2006+A1:2010 |
| UDA1693SUB2V    | SUBWAY   | Shower tray Acryl   | EN 14527:2006+A1:2010 |
| UDA1835SUB2V    | SUBWAY   | Shower tray Acryl   | EN 14527:2006+A1:2010 |
| UDA1893SUB2V    | SUBWAY   | Shower tray Acryl   | EN 14527:2006+A1:2010 |
| UDQ0806FUT1GV   | FUTURION | Shower tray Quarryl | EN 14527:2006+A1:2010 |
| UDQ0806FUT1LIGV | FUTURION | Shower tray Quarryl | EN 14527:2006+A1:2010 |
| UDQ0806FUT1REGV | FUTURION | Shower tray Quarryl | EN 14527:2006+A1:2010 |
| UDQ0806FUT1RLGV | FUTURION | Shower tray Quarryl | EN 14527:2006+A1:2010 |
| UDQ0806FUT1V    | FUTURION | Shower tray Quarryl | EN 14527:2006+A1:2010 |

## Appendix to the Declaration of Performance for N3213-01

|                 |               |                    |                       |
|-----------------|---------------|--------------------|-----------------------|
| UDQ0906FUT1GV   | FUTURION      | Shower tray Quaryl | EN 14527:2006+A1:2010 |
| UDQ0906FUT1V    | FUTURION      | Shower tray Quaryl | EN 14527:2006+A1:2010 |
| UDQ0906FUT4GV   | FUTURION      | Shower tray Quaryl | EN 14527:2006+A1:2010 |
| UDQ0906FUT4PFV  | FUTURION      | Shower tray Quaryl | EN 14527:2006+A1:2010 |
| UDQ0906FUT4V    | FUTURION      | Shower tray Quaryl | EN 14527:2006+A1:2010 |
| UDQ0906FUT5GV   | FUTURION      | Shower tray Quaryl | EN 14527:2006+A1:2010 |
| UDQ0906FUT5V    | FUTURION      | Shower tray Quaryl | EN 14527:2006+A1:2010 |
| UDQ1006FUT1GV   | FUTURION      | Shower tray Quaryl | EN 14527:2006+A1:2010 |
| UDQ1006FUT1LIGV | FUTURION      | Shower tray Quaryl | EN 14527:2006+A1:2010 |
| UDQ1006FUT1REGV | FUTURION      | Shower tray Quaryl | EN 14527:2006+A1:2010 |
| UDQ1006FUT1RLGV | FUTURION      | Shower tray Quaryl | EN 14527:2006+A1:2010 |
| UDQ1006FUT1V    | FUTURION      | Shower tray Quaryl | EN 14527:2006+A1:2010 |
| UDQ1006FUT4GV   | FUTURION      | Shower tray Quaryl | EN 14527:2006+A1:2010 |
| UDQ1286FUT2GV   | FUTURION      | Shower tray Quaryl | EN 14527:2006+A1:2010 |
| UDQ1286FUT2HV   | FUTURION      | Shower tray Quaryl | EN 14527:2006+A1:2010 |
| UDQ1286FUT2V    | FUTURION      | Shower tray Quaryl | EN 14527:2006+A1:2010 |
| UDQ1296FUT2GV   | FUTURION      | Shower tray Quaryl | EN 14527:2006+A1:2010 |
| UDQ1296FUT2HV   | FUTURION      | Shower tray Quaryl | EN 14527:2006+A1:2010 |
| UDQ1296FUT2V    | FUTURION      | Shower tray Quaryl | EN 14527:2006+A1:2010 |
| UDQ1516FUT2GV   | FUTURION      | Shower tray Quaryl | EN 14527:2006+A1:2010 |
| UDQ1516FUT2HV   | FUTURION      | Shower tray Quaryl | EN 14527:2006+A1:2010 |
| UDQ1516FUT2RLGV | FUTURION      | Shower tray Quaryl | EN 14527:2006+A1:2010 |
| UDQ1516FUT2RRGV | FUTURION      | Shower tray Quaryl | EN 14527:2006+A1:2010 |
| UDQ1516FUT2V    | FUTURION      | Shower tray Quaryl | EN 14527:2006+A1:2010 |
| UDQ1806FUT2GV   | FUTURION      | Shower tray Quaryl | EN 14527:2006+A1:2010 |
| UDQ1806FUT2RLGV | FUTURION      | Shower tray Quaryl | EN 14527:2006+A1:2010 |
| UDQ1806FUT2RRGV | FUTURION      | Shower tray Quaryl | EN 14527:2006+A1:2010 |
| UDQ1806FUT2V    | FUTURION      | Shower tray Quaryl | EN 14527:2006+A1:2010 |
| UDQ9706FUT2GV   | FUTURION      | Shower tray Quaryl | EN 14527:2006+A1:2010 |
| UDQ9706FUT2RLGV | FUTURION      | Shower tray Quaryl | EN 14527:2006+A1:2010 |
| UDQ9706FUT2RRGV | FUTURION      | Shower tray Quaryl | EN 14527:2006+A1:2010 |
| UDQ9706FUT2V    | FUTURION      | Shower tray Quaryl | EN 14527:2006+A1:2010 |
| UDQ9806FUT2GV   | FUTURION      | Shower tray Quaryl | EN 14527:2006+A1:2010 |
| UDQ9806FUT2V    | FUTURION      | Shower tray Quaryl | EN 14527:2006+A1:2010 |
| UDQ0900FFL1CV   | FUTURION FLAT | Shower tray Quaryl | EN 14527:2006+A1:2010 |
| UDQ0900FFL1V    | FUTURION FLAT | Shower tray Quaryl | EN 14527:2006+A1:2010 |
| UDQ1000FFL1CV   | FUTURION FLAT | Shower tray Quaryl | EN 14527:2006+A1:2010 |
| UDQ1000FFL1V    | FUTURION FLAT | Shower tray Quaryl | EN 14527:2006+A1:2010 |
| UDQ1280FFL2V    | FUTURION FLAT | Shower tray Quaryl | EN 14527:2006+A1:2010 |
| UDQ1290FFL2CV   | FUTURION FLAT | Shower tray Quaryl | EN 14527:2006+A1:2010 |
| UDQ1290FFL2V    | FUTURION FLAT | Shower tray Quaryl | EN 14527:2006+A1:2010 |
| UDQ1490FFL2CV   | FUTURION FLAT | Shower tray Quaryl | EN 14527:2006+A1:2010 |
| UDQ1490FFL2V    | FUTURION FLAT | Shower tray Quaryl | EN 14527:2006+A1:2010 |

## Appendix to the Declaration of Performance for N3213-01

|               |                 |                    |                       |
|---------------|-----------------|--------------------|-----------------------|
| UDQ1510FFL2V  | FUTURION FLAT   | Shower tray Quaryl | EN 14527:2006+A1:2010 |
| UDQ1690FFL2V  | FUTURION FLAT   | Shower tray Quaryl | EN 14527:2006+A1:2010 |
| UDQ1800FFL2V  | FUTURION FLAT   | Shower tray Quaryl | EN 14527:2006+A1:2010 |
| UDQ1890FFL2V  | FUTURION FLAT   | Shower tray Quaryl | EN 14527:2006+A1:2010 |
| UDQ9800FFL2V  | FUTURION FLAT   | Shower tray Quaryl | EN 14527:2006+A1:2010 |
| UDQ0910SQR1GV | SQUARO          | Shower tray Quaryl | EN 14527:2006+A1:2010 |
| UDQ0910SQR1N  | SQUARO          | Shower tray Quaryl | EN 14527:2006+A1:2010 |
| UDQ0910SQR1V  | SQUARO          | Shower tray Quaryl | EN 14527:2006+A1:2010 |
| UDQ0910SQR1   | SQUARO          | Shower tray Quaryl | EN 14527:2006+A1:2010 |
| UDQ0910SQR4GV | SQUARO          | Shower tray Quaryl | EN 14527:2006+A1:2010 |
| UDQ0910SQR4V  | SQUARO          | Shower tray Quaryl | EN 14527:2006+A1:2010 |
| UDQ0910SQR4   | SQUARO          | Shower tray Quaryl | EN 14527:2006+A1:2010 |
| UDQ1010SQR1GV | SQUARO          | Shower tray Quaryl | EN 14527:2006+A1:2010 |
| UDQ1010SQR1V  | SQUARO          | Shower tray Quaryl | EN 14527:2006+A1:2010 |
| UDQ1010SQR1   | SQUARO          | Shower tray Quaryl | EN 14527:2006+A1:2010 |
| UDQ1290SQR2GV | SQUARO          | Shower tray Quaryl | EN 14527:2006+A1:2010 |
| UDQ1290SQR2N  | SQUARO          | Shower tray Quaryl | EN 14527:2006+A1:2010 |
| UDQ1290SQR2V  | SQUARO          | Shower tray Quaryl | EN 14527:2006+A1:2010 |
| UDQ1290SQR2   | SQUARO          | Shower tray Quaryl | EN 14527:2006+A1:2010 |
| UDQ1490SQR2GV | SQUARO          | Shower tray Quaryl | EN 14527:2006+A1:2010 |
| UDQ1490SQR2V  | SQUARO          | Shower tray Quaryl | EN 14527:2006+A1:2010 |
| UDQ1490SQR2   | SQUARO          | Shower tray Quaryl | EN 14527:2006+A1:2010 |
| UDQ1690SQR2GV | SQUARO          | Shower tray Quaryl | EN 14527:2006+A1:2010 |
| UDQ1690SQR2V  | SQUARO          | Shower tray Quaryl | EN 14527:2006+A1:2010 |
| UDQ1690SQR2   | SQUARO          | Shower tray Quaryl | EN 14527:2006+A1:2010 |
| UDQ1780SQR2GV | SQUARO          | Shower tray Quaryl | EN 14527:2006+A1:2010 |
| UDQ1780SQR2V  | SQUARO          | Shower tray Quaryl | EN 14527:2006+A1:2010 |
| UDQ1780SQR2   | SQUARO          | Shower tray Quaryl | EN 14527:2006+A1:2010 |
| UDQ1890SQR2GV | SQUARO          | Shower tray Quaryl | EN 14527:2006+A1:2010 |
| UDQ1890SQR2V  | SQUARO          | Shower tray Quaryl | EN 14527:2006+A1:2010 |
| UDQ1890SQR2   | SQUARO          | Shower tray Quaryl | EN 14527:2006+A1:2010 |
| UDQ9800SQI2V  | SQUARO INFINITY | Shower tray Quaryl | EN 14527:2006+A1:2010 |
| UDQ0900SQI2V  | SQUARO INFINITY | Shower tray Quaryl | EN 14527:2006+A1:2010 |
| UDQ1010SQI2V  | SQUARO INFINITY | Shower tray Quaryl | EN 14527:2006+A1:2010 |
| UDQ1090SQI2V  | SQUARO INFINITY | Shower tray Quaryl | EN 14527:2006+A1:2010 |
| UDQ1280SQI2V  | SQUARO INFINITY | Shower tray Quaryl | EN 14527:2006+A1:2010 |
| UDQ1290SQI2V  | SQUARO INFINITY | Shower tray Quaryl | EN 14527:2006+A1:2010 |
| UDQ1480SQI2V  | SQUARO INFINITY | Shower tray Quaryl | EN 14527:2006+A1:2010 |
| UDQ1490SQI2V  | SQUARO INFINITY | Shower tray Quaryl | EN 14527:2006+A1:2010 |
| UDQ1680SQI2V  | SQUARO INFINITY | Shower tray Quaryl | EN 14527:2006+A1:2010 |
| UDQ1690SQI2V  | SQUARO INFINITY | Shower tray Quaryl | EN 14527:2006+A1:2010 |
| UDQ1810SQI2V  | SQUARO INFINITY | Shower tray Quaryl | EN 14527:2006+A1:2010 |
| UDQ1880SQI2V  | SQUARO INFINITY | Shower tray Quaryl | EN 14527:2006+A1:2010 |



## Appendix to the Declaration of Performance for N3213-01

|               |        |                     |                       |
|---------------|--------|---------------------|-----------------------|
| UDQ9090EXI1V  | Arto   | Shower tray Quaryl  | EN 14527:2006+A1:2010 |
| UDQ1090EXI2V  | Arto   | Shower tray Quaryl  | EN 14527:2006+A1:2010 |
| UDQ1010EXI1V  | Arto   | Shower tray Quaryl  | EN 14527:2006+A1:2010 |
| UDQ1280EXI2V  | Arto   | Shower tray Quaryl  | EN 14527:2006+A1:2010 |
| UDQ1290EXI2V  | Arto   | Shower tray Quaryl  | EN 14527:2006+A1:2010 |
| UDQ1480EXI2V  | Arto   | Shower tray Quaryl  | EN 14527:2006+A1:2010 |
| UDQ1490EXI2V  | Arto   | Shower tray Quaryl  | EN 14527:2006+A1:2010 |
| UDQ1690EXI2V  | Arto   | Shower tray Quaryl  | EN 14527:2006+A1:2010 |
| UDQ1810EXI2V  | Arto   | Shower tray Quaryl  | EN 14527:2006+A1:2010 |
| UDQ1410EXI2IV | Arto   | Shower tray Quaryl  | EN 14527:2006+A1:2010 |
|               |        |                     |                       |
| UDG8080EXC1V  | Stoneo | Shower tray Gelcoat | EN 14527:2006+A1:2010 |
| UDG9090EXC1V  | Stoneo | Shower tray Gelcoat | EN 14527:2006+A1:2010 |
| UDG1080EXC2V  | Stoneo | Shower tray Gelcoat | EN 14527:2006+A1:2010 |
| UDG1090EXC2V  | Stoneo | Shower tray Gelcoat | EN 14527:2006+A1:2010 |
| UDG1280EXC2V  | Stoneo | Shower tray Gelcoat | EN 14527:2006+A1:2010 |
| UDG1290EXC2V  | Stoneo | Shower tray Gelcoat | EN 14527:2006+A1:2010 |
| UDG1490EXC2V  | Stoneo | Shower tray Gelcoat | EN 14527:2006+A1:2010 |
| UDG1690EXC2V  | Stoneo | Shower tray Gelcoat | EN 14527:2006+A1:2010 |
| UDG1890EXC2V  | Stoneo | Shower tray Gelcoat | EN 14527:2006+A1:2010 |
| UDG2090EXC2V  | Stoneo | Shower tray Gelcoat | EN 14527:2006+A1:2010 |