

WASHBASINS O.NOVO

PRODUCT INFORMATION

1 . POSITION



Article number	73274001
Article title	Villeroy & Boch O.novo Corner handwashbasin Compact, 415 x 415 x 195 mm, White Alpin, with overflow, unground
Product designation	Corner handwashbasin Compact
Collection	O.novo
PROJECTS	■ START
Assembly / Assembly type	Corner installation
Scope of delivery	1 x corner handwashbasin
Length in mm	415
Width in mm	415
Height in mm	195
Side length in mm	415
Interior depth	145
Weight in kg	10,95
Number of tap holes punched through	1
Position of drill hole	central tap hole punched out
express delivery	No
Suitable for	1-hole mixer
Material	Sanitary ceramics
Surface	glossy
Colour name	White Alpin
With overflow	Yes
EAN number	4022693255044

COLOUR

COLOUR DESIGNATION





White Alpin

TECHNICAL DRAWINGS

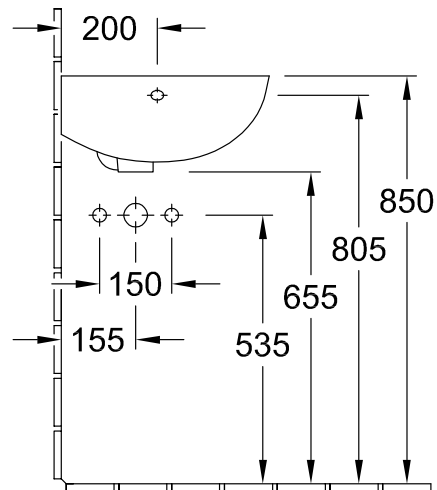
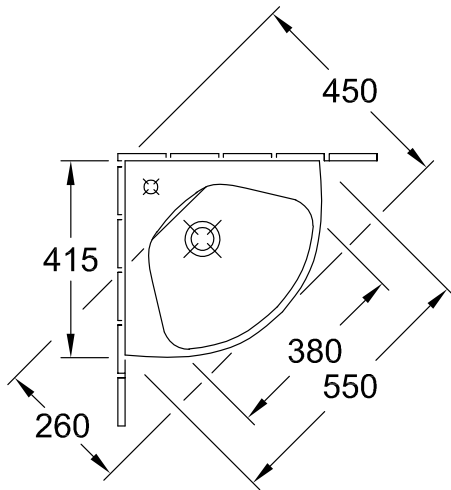
73274001

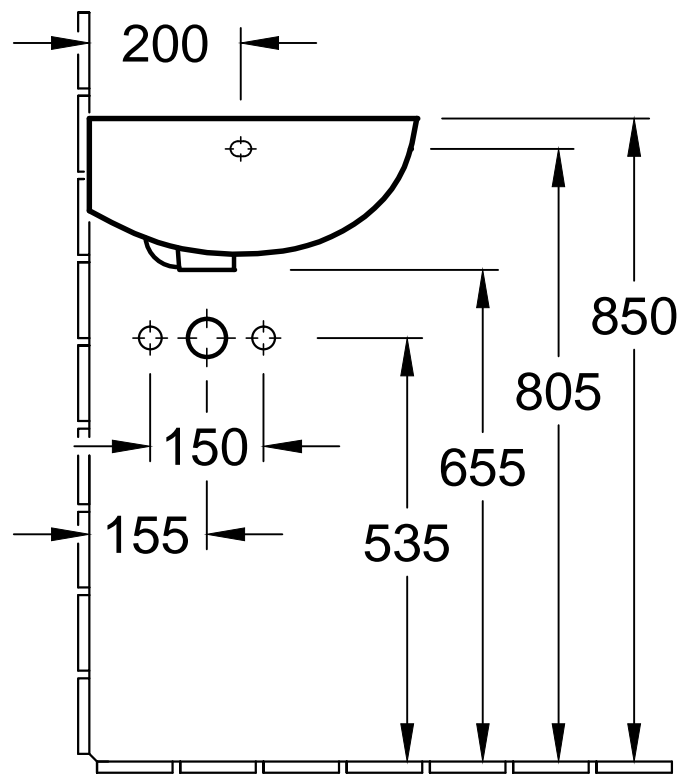
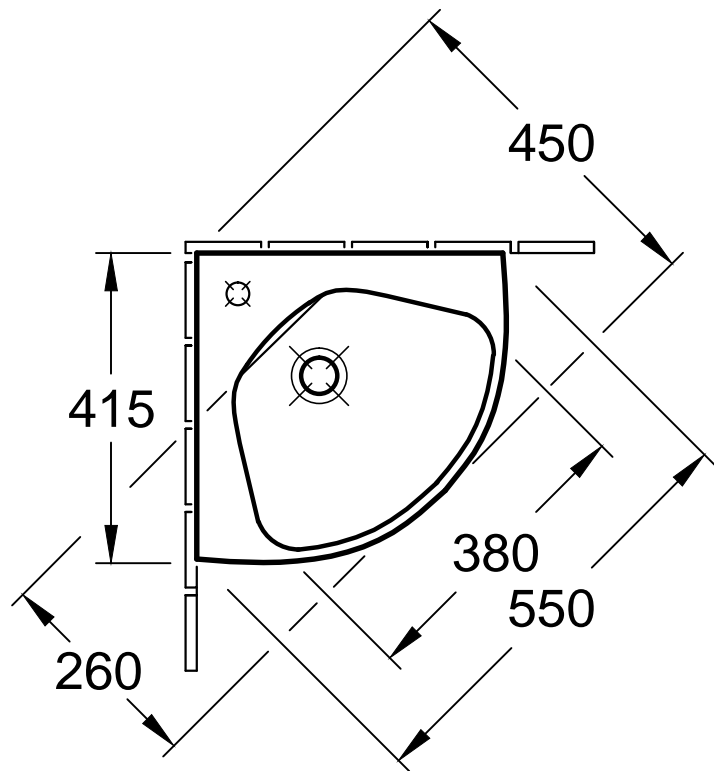



<p>O.novo 7327 40</p>	
<p>V02 / 20.05.2015</p>	<p>Villeroy & Boch 1748</p>

LEISTUNGSERKLÄRUNG

Sprache DE
Original

A113 - 0001

(Artikelnummer siehe Liste im Anhang)
Einbauwaschbecken, Unterbauwaschbecken,
Vorbauwaschbecken, Waschbecken, Aufsatzwaschbecken

1. Eindeutiger Kenncode des Produkttyps

Die Liste der Produkte befindet sich im Anhang.

2. Verwendungszweck(e)

persönliche Hygiene

3. Hersteller

Villeroy & Boch AG
Saarferstraße
66693 Mettlach
Deutschland

+49 (0) 68 64 / 8 10
information@villeroy-boch.com
www.villeroy-boch.com

4. Bevollmächtigter

Nicht anwendbar

5. System(e) zur Bewertung und Überprüfung der Leistungsbeständigkeit

Der Leistungsnachweis erfolgt nach System 4.

6. Harmonisierte Norm & 7. Erklärte Leistung(en)

Notifizierte Stelle(n) - Nicht anwendbar

Wesentliche Merkmale	Leistung	Harmonisierte Norm
statische Belastbarkeit (LR)	bestanden	EN 14688:2006
Reinigbarkeit (CA)	bestanden	EN 14688:2006
Dauerhaftigkeit (DA)	bestanden	EN 14688:2006
Abflusswert des Überlaufes (OF)	bestanden	EN 14688:2006

Die Leistung des Produkts entspricht der erklärten Leistung/den erklärten Leistungen. Für die Erstellung der Leistungserklärung im Einklang mit der Verordnung (EU) Nr. 305/2011 ist allein der oben genannte Hersteller verantwortlich.

Unterzeichnet für den Hersteller und im Namen des Herstellers von:

Mettlach, 18.1.2024

Ort und Datum

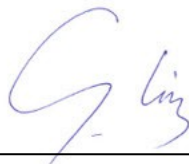

Unterschrift

Georg Lörz
Mitglied der Geschäftsführung
Leiter des Unternehmensbereichs Bad und Wellness

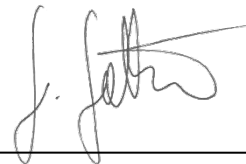

Unterschrift

Giovanni Gattone
Technischer Direktor/Head of Manufacturing

PROHLÁŠENÍ O VLASTNOSTECH

Jazyk CS
Překlad

A113 - 0001

(Objednací číslo výrobku, viz seznam v příloze)
Vestavěné umyvadlo, umyvadlo k zabudování pod desku,
polozápustné umyvadlo, umyvadlo, umyvadlo k postavení
na desku

1. Jedinečný identifikační kód typu výrobku

Seznam výrobků přiložen.

2. Zamýšlené/zamýšlená použití:

Osobní hygiena

3. Výrobce

Villeroy & Boch AG
Saarferstraße
66693 Mettlach
Německo

+49 (0) 68 64 / 8 10
information@villeroy-boch.com
www.villeroy-boch.com

4. Zplnomocněný zástupce:

netýká se

5. Systém/systémy POSV

Prohlášení o vlastnostech se vydává ve smyslu systému č. 4.

6. Harmonizovaná norma & 7. Deklarovaná vlastnost/Deklarované vlastnosti

Oznámené subjekt - netýká se

Základní vlastnosti	Funkční vlastnosti	Harmonizovaná norma
Zatížitelnost (LR)	Vyhovuje	EN 14688:2006
Čistitelnost (CA)	Vyhovuje	EN 14688:2006
Životnost (DA)	Vyhovuje	EN 14688:2006
Rychlost přetečení (OF)	Vyhovuje	EN 14688:2006

Vlastnosti výše uvedeného výrobku jsou ve shodě se souborem deklarovaných vlastností. Toto prohlášení o vlastnostech se v souladu s nařízením (EU) c. 305/2011 vydává na výhradní odpovědnost výrobce uvedeného výše.

Podepsáno za výrobce a jeho jménem:

Mettlach, 18.1.2024

Místo a datum

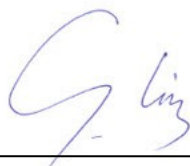

Podpis

Georg Lörz
Člen vedení společnosti
vedoucí divize Koupelny a wellness

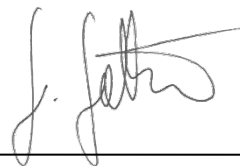

Podpis

Giovanni Gattone
Technický ředitel/Head of Manufacturing



DECLARATION OF PERFORMANCE

Language EN-GB
Translation

A113 - 0001

(Item number: see list in Appendix)
Build-in washbasin, undercounter basin, semi-recessed washbasin, washbasin, surface-mounted washbasin

1. Unique identification code of the product-type

The list of products can be found in the Appendix

2. Intendes use/es

Personal Hygiene

3. Manufacturer

Villeroy & Boch AG
Saaruferstraße
66693 Mettlach
Germany

+49 (0) 68 64 / 8 10

information@villeroy-boch.com

www.villeroy-boch.com

4. Authorised Representative

Not applicable

5. System/s of AVCP

The certificate of performance is awarded pursuant to System 4.

6. Harmonized Standard & 7. Declared Performance

Notified body/ies - Not applicable

Essential Characteristics	Performance	Harmonized standard
Load resistance (LR)	passed	EN 14688:2006
Cleanability (CA)	passed	EN 14688:2006
Durability (DA)	passed	EN 14688:2006
Overflow rate (OF)	passed	EN 14688:2006

The performance of the product identified above is in conformity with the set of declared performance/s. This declaration of performance is issued, in accordance with Regulation (EU) No 305/2011, under the sole responsibility of the manufacturer identified above.

Signed for and on behalf of the manufacturer by:

Mettlach, 18.1.2024

Place and date

Signature

Georg Lörz
Member of the Management Board
Head of Bathroom and Wellness Division

Signature

Giovanni Gattone
Technical Director/Head of Manufacturing



DECLARATION OF PERFORMANCE

Language EN-GB_UK
Translation

A113 - 0001

(Item number: see list in Appendix)
Build-in washbasin, undercounter basin, semi-recessed washbasin, washbasin, surface-mounted washbasin

1. Unique identification code of the product-type

The list of products can be found in the Appendix

2. Intendes use/es

Personal Hygiene

3. Manufacturer

Villeroy & Boch AG
Saaruferstraße
66693 Mettlach
Germany

+49 (0) 68 64 / 8 10

information@villeroy-boch.com

www.villeroy-boch.com

4. Authorised Representative

Not applicable

5. System/s of AVCP

The certificate of performance is awarded pursuant to System 4.

6. Harmonized Standard & 7. Declared Performance

Notified body/ies - Not applicable

Key features	Performance	Harmonized standard
Load resistance (LR)	passed	EN 14688:2006
Cleanability (CA)	passed	EN 14688:2006
Durability (DA)	passed	EN 14688:2006
Overflow rate (OF)	passed	EN 14688:2006

The performance of the product identified above is in conformity with the set of declared performance/s. This declaration of performance is issued, in accordance with 465/2019 (UK) exiting the European Union building and building construction market standards, under the sole responsibility of the manufacturer identified above.

Signed for and on behalf of the manufacturer by:

Mettlach, 18.1.2024

Place and date

Signature

Georg Lörz
Member of the Management Board
Head of Bathroom and Wellness Division

Signature

Giovanni Gattone
Technical Director/Head of Manufacturing



DÉCLARATION DES PERFORMANCES

Langue FR
Traduction

A113 - 0001

Références des articles : voir la liste en annexe)
Vasque à encastrer par-dessus, vasque à encastrer par-dessous, vasque semi encastrée, lavabo, vasque à poser

1. Code d'identification unique du produit type

La liste des produits se trouve en annexe.

2. Usage(s) prévu(s)

Hygiène corporelle

3. Fabricant

Villeroy & Boch AG
Saaruferstraße
66693 Mettlach
Allemagne

+49 (0) 68 64 / 8 10

information@villeroy-boch.com

www.villeroy-boch.com

4. Mandataire

Sans objet

5. Système(s) d'évaluation et de vérification de la constance des performances

L'attestation de performance est effectuée selon le système 4

6. Norme harmonisée & 7. Performance(s) d'éclairée(s)

Organisme(s) notifié(s) - Sans objet

caractéristique essentielle	Performance	Norme harmonisée
Résistance (LR)	exigance satisfaite	EN 14688:2006
Nettoyabilité (CA)	exigance satisfaite	EN 14688:2006
Longévité (DA)	exigance satisfaite	EN 14688:2006
Performance de trop-plein (OF)	exigance satisfaite	EN 14688:2006

Les performances du produit identifié ci-dessus sont conformes aux performances déclarées. Conformément au règlement (UE) no 305/2011, la présente déclaration des performances est établie sous la seule responsabilité du fabricant mentionné ci-dessus.

Signé pour le fabricant et en son nom par:

Mettlach, 18.1.2024

Lieu et date

Signature

Georg Lörz
Membres de la direction
Directeur de la division Salle de bains et Wellness

Signature

Giovanni Gattone
Directeur technique/Head of Manufacturing

TELJESÍTMÉNY NYILATKOZAT

Nyelv HU
Fordítás

A113 - 0001

(A cikkszámokat lásd a függelékben található listában)
Beépíthető mosdó, alulról beépíthető mosdó, előlről
beépíthető mosdó, mosdó, ráültethető mosdó

1. A terméktípus egyedi azonosító kódja

A termékek listája a függelékben található.

2. Felhasználás célja(i)

Testi higiénia

3. Gyártó

Villeroy & Boch AG
Saarferstraße
66693 Mettlach
Németország

+49 (0) 68 64 / 8 10
information@villeroy-boch.com
www.villeroy-boch.com

4. A meghatalmazott képviselő

Nem alkalmazható

5. Az AVCP-rendszer(ek)

A teljesítmény igazolása a 4-es rendszer szerint történik.

6. Harmonizált szabvány & 7. A nyilatkozatban szereplő teljesítmény(ek)

Bejelentett szerv(ek) - Nem alkalmazható

Döntő jellemzők	Teljesítmény	Harmonizált szabvány
Terhelhetőség (LR)	megfelelt	EN 14688:2006
Tisztíthatóság (CA)	megfelelt	EN 14688:2006
Élettartam (DA)	megfelelt	EN 14688:2006
Túlfolyó-teljesítmény (OF)	megfelelt	EN 14688:2006

A fent azonosított termék teljesítménye megfelel a bejelentett teljesítmény(ek)nek. A 305/2011/EU rendeletnek megfelelően e teljesítménynyilatkozat kiadásáért kizárólag a fent meghatározott gyártó a felelős.

A gyártó nevében és részéről aláíró személy:

Mettlach, 18.1.2024

Hely és dátum

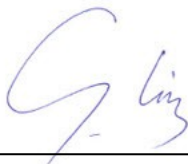

Aláírás

Georg Lörz
A menedzsment tagja
A Fürdőszoba és Wellness részleg vezetője

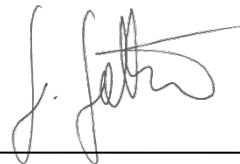

Aláírás

Giovanni Gattone
Műszaki igazgató/Gyártásvezető

DICHIARAZIONE DI PRESTAZIONE

Lingua IT
Traduzione

A113 - 0001

(Per i codici articolo si veda la lista nell'allegato)
Lavabo da incasso, lavabo sottopiano, lavabo da
semincasso, lavabo, lavabo da appoggio

1. Codice di identificazione unico del prodotto-tipo

La lista dei prodotti è riportata nell'allegato.

2. Usi previsti

Lavelli da cucina

3. Fabbricante

Villeroy & Boch AG
Saaruferstraße
66693 Mettlach
Germania

+49 (0) 68 64 / 8 10

information@villeroy-boch.com

www.villeroy-boch.com

4. Mandatorio

non applicabile

5. Simstemi di VVCP

La prestazione viene comprovata secondo il Sistema 4.

6. Norma armonizzata & 7. Prestazioni dichiarate

Organismi notificati - non applicabile

caratteristica elencata	Prestazione	Norma armonizzata
Livello di rumore (LR)	superata	EN 14688:2006
Pulibilità (CA)	superata	EN 14688:2006
Durata utile (DA)	superata	EN 14688:2006
Prestazione del Troppopieno (OF)	superata	EN 14688:2006

La prestazione del prodotto sopra identificato è conforme all'insieme delle prestazioni dichiarate. La presente dichiarazione di responsabilità viene emessa, in conformità al regolamento (UE) n. 305/2011, sotto la sola responsabilità del fabbricante sopra identificato.

Firmato a nome e per conto di:

Mettlach, 18.1.2024

Luogo e data

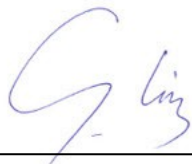

Firma

Georg Lörz
Membro della Direzione
Responsabile del settore Bagno e Wellness

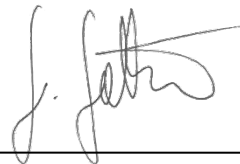

Firma

Giovanni Gattone
Direttore tecnico/Head of Manufacturing

PRESTATIEVERKLARING

Taal NL
Vertaling

A113 - 0001

(Artikelnummer zie lijst in de bijlage)
Inbouwwastafel, onderbouwwastafel, voorbouwwastafel,
wastafel, opzetwastafel

1. Unieke identificatiecode van het producttype

De lijst met producten bevindt zich in de bijlage.

2. Beoogd(e) gebruik(en)

Lichaamshygiëne

3. Fabrikant

Villeroy & Boch AG
Saarferstraße
66693 Mettlach
Duitsland

+49 (0) 68 64 / 8 10
information@villeroy-boch.com
www.villeroy-boch.com

4. Gemachtigde

niet toepasbaar

5. Het systeem of de systemen voor de beoordeling en verificatie van de prestatiebestendigheid

Het bewijs voor de geleverde prestatie wordt aangetoond door systeem 4.

6. Geharmoniseerde norm & 7. Aangegeven prestatie(s)

Aangemelde instantie(s) - niet toepasbaar

essentieel kenmerk	prestatie	Geharmoniseerde norm
Belastbaarheid (LR)	test doorstaan	EN 14688:2006
Schoonmaakgemak (CA)	test doorstaan	EN 14688:2006
Levensduur (DA)	test doorstaan	EN 14688:2006
Overloopcapaciteit (OF)	test doorstaan	EN 14688:2006

De prestaties van het hierboven omschreven product zijn conform de aangegeven prestaties. Deze prestatieverklaring wordt in overeenstemming met Verordening (EU) nr. 305/2011 onder de exclusieve verantwoordelijkheid van de hierboven vermelde fabrikant verstrekt.

Ondertekend voor en namens de fabrikant door:

Mettlach, 18.1.2024

Plaats en datum

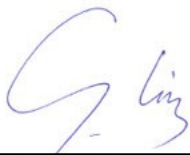

Handtekening

Georg Lörz
Lid van de raad van bestuur
Hoofd van de afdeling Badkamer en Wellness

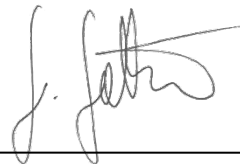

Handtekening

Giovanni Gattone
Technisch directeur/Head of Manufacturing

DEKLARACJA WŁAŚCIWOŚCI UŻYTKOWYCH

Język PL
Tłumaczenie

A113 - 0001

(Numer artykułu znajduje się na liście w załączniku)
Umywalka nablutowa, umywalka podblatowa, umywalka do wbudowania z przodu, umywalka, umywalka stojąca na blacie, umywalka meblowa

1. Niepowtarzalny kod identyfikacyjny typu wyrobu

Lista wyrobów znajduje się w załączniku.

2. Zamierzone zastosowanie lub zastosowania

Higiena osobista.

3. Producent

Villeroy & Boch AG
Saarferstraße
66693 Mettlach
Niemcy

+49 (0) 68 64 / 8 10
information@villeroy-boch.com
www.villeroy-boch.com

4. Upoważniony przedstawiciel

nie dotyczy

5. System(-y) oceny i weryfikacji stałości właściwości użytkowych

Ocena i weryfikacja stałości właściwości użytkowych według systemu 4

6. Norma zharmonizowana & 7. Deklarowane właściwości użytkowe

Jednostka lub jednostki notyfikowane: - nie dotyczy

charakterystyk określonych	Właściwość użytkowa	Norma zharmonizowana
Odporność na obciążenie (LR)	spełnia	EN 14688:2006
Zdolność do czyszczenia (CA)	spełnia	EN 14688:2006
Trwałość (DA)	spełnia	EN 14688:2006
Wydajność przelewu (OF)	spełnia	EN 14688:2006

Właściwości użytkowe określonego powyżej wyrobu są zgodne z zestawem deklarowanych właściwości użytkowych. Niniejsza deklaracja właściwości użytkowych wydana zostaje zgodnie z rozporządzeniem (UE) nr 305/2011 na wyłączną odpowiedzialność producenta określonego powyżej.

W imieniu producenta podpisał:

Mettlach, 18.1.2024

Miejsce i data

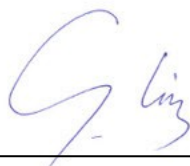

Podpis

Georg Lörz
Członek dyrekcji
Kierownik działu Łazienka i wellness

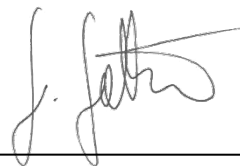

Podpis

Giovanni Gattone
Dyrektor techniczny / Head of Manufacturing

VYHLÁSENIE O VLASTNOSTIACH

Jazyk SK
Preklad

A113 - 0001

(Objednávacie číslo výrobku, viď zoznam v prílohe)
Vstavané umývadlo, umývadlo zabudovateľné pod dosku,
polozápusťné umývadlo, umývadlo, umývadlo osaditeľné
na dosku

1. Jedinečný identifikačný kód typu výrobku

Zoznam výrobkov je uvedený v prílohe.

2. Zamýšľané použitie/použitia

Osobná hygiena

3. Výrobca

Villeroy & Boch AG
Saarferstraße
66693 Mettlach
Nemecko

+49 (0) 68 64 / 8 10

information@villeroy-boch.com

www.villeroy-boch.com

4. Splnomocnený zástupca

neuplatňuje sa

5. Systém(-y) posudzovania a overovania nemennosti parametrov

Vyhlásenie o vlastnostiach sa vydáva v zmysle systému č. 4.

6. Harmonizovaná norma & 7. Deklarované parametre

Notifikovaný(-é) subjekt(-y) - neuplatňuje sa

podstatných vlastností	parametre	Harmonizovaná norma
Zaťažiteľnosť (LR)	Vyhovuje	EN 14688:2006
Čistiteľnosť (CA)	Vyhovuje	EN 14688:2006
Životnosť (DA)	Vyhovuje	EN 14688:2006
Rýchlosť pretečenia (OF)	Vyhovuje	EN 14688:2006

Uvedené parametre výrobku sú v zhode so súborom deklarovaných parametrov. Toto vyhlásenie o parametroch sa v súlade nariadenin (EÚ) c. 305/2011 vydáva na výhradnú zodpovednosť uvedeného výrobcu

Podpísal za a v mene výrobcu

Mettlach, 18.1.2024

Miesto a dátum

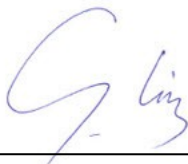

Podpis

Georg Lörz
Člen vedenia spoločnosti
Riaditeľ úseku Kúpeľne a wellness

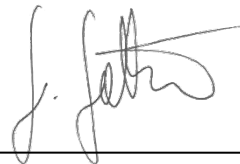

Podpis

Giovanni Gattone
Technický riaditeľ/Head of Manufacturing



DECLARACIÓN DE RENDIMIENTO

Lengua ES
Traducción

A113 - 0001

(Ver referencia en la lista adjunta)
Lavabo de encastre, lavabo de sotoencastre, lavabo de
semiencastré, lavabo, lavabo sobre encimera

1. Código de identificación única del producto tipo

Se adjunta lista de productos.

2. Usos previstos

Higiene corporal

3. Fabricante

Villeroy & Boch AG
Saaruferstraße
66693 Mettlach
Alemania

+49 (0) 68 64 / 8 10
information@villeroy-boch.com
www.villeroy-boch.com

4. Representante autorizado

ei kohaldata

5. Sistemas de evaluación y verificación de la constancia de las prestaciones (EVSP)

Certificado de rendimiento según sistema 4.

6. Norma armonizada & 7. Prestaciones declaradas

Organismos notificados - ei kohaldata

características esenciales	Prestaciones	Norma armonizada
Capacidad de carga (LR)	suficiente	EN 14688:2006
Facilidad de limpieza (CA)	suficiente	EN 14688:2006
Durabilidad (DA)	suficiente	EN 14688:2006
Rendimiento de enjuague (OF)	suficiente	EN 14688:2006

Las prestaciones del producto identificado anteriormente son conformes con el conjunto de prestaciones declaradas. La presente declaración de prestaciones se emite, de conformidad con el Reglamento (UE) no 305/2011, bajo la sola responsabilidad del fabricante arriba identificado.

Firmado por y en nombre del fabricante por:

Mettlach, 18.1.2024

Lugar y fecha

Firma

Georg Lörz
Miembro de la dirección
Director de la División Baño y Wellness

Firma

Giovanni Gattone
Director técnico/Head of Manufacturing

ДЕКЛАРАЦИЯ ЗА ЕКСПЛОАТАЦИОННИ ПОКАЗАТЕЛИ

A113 - 0001

език BG
Превод

(за номера на артикула вижте списъка в
приложението)
Вградени мивки, мивки под плот, мивки с преден
монтаж, мивки, мивки върху плот

1. Уникален идентификационен код на типа продукт

Списъкът с продукти може да бъде намерен в приложението.

2. Предвидена употреба/употреби

лична хигиена

3. Производител

Villeroy & Boch AG
Saarferstraße
66693 Mettlach
Германия

+49 (0) 68 64 / 8 10
information@villeroy-boch.com
www.villeroy-boch.com

4. Упълномощен представител

неприложимо

5. Система/системи за оценяване и проверка на постоянството на експлоатационните показатели

Доказването на експлоатационните показатели се извършва съгласно система 4.

6. Хармонизиран стандарт & 7. Декларираните експлоатационни показатели

Нотифициран орган/органи - неприложимо

Съществени характеристики	Показател	Хармонизиран стандарт
Статична товарносимост (LR)	покрито	EN 14688:2006
Възможност за почистване (CA)	покрито	EN 14688:2006
Трайност (DA)	покрито	EN 14688:2006
Скорост на отвеждане на преливника (OF)	покрито	EN 14688:2006

Експлоатационните показатели на продукта съответстват на декларираните експлоатационни показатели. Посоченият по-горе производител е единствено отговорен за изготвянето на декларацията за експлоатационни показатели в съответствие с Регламент (ЕС) № 305/2011.

Подписано за и от името на производителя от:

Mettlach, 18.1.2024

Място и дата

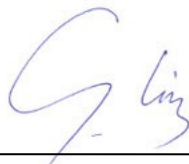

Подпис

Georg Lörz
Член на управителния съвет
Ръководител на бизнес направление „Баня и
уелнес“

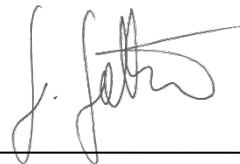

Подпис

Giovanni Gattone
Технически директор/ръководител производство

YDEEVNEDEKLARATION

Sprog DA
Oversættelse

A113 - 0001

(Artikelnummer se vedlagte liste)
Indbygningstvask, undermonteret tvask, frontmonteret tvask,
håndtvask, håndtvask til bordplade

1. Varetypens unikke identifikationskode

Listen over produkter er vedlagt.

2. Tilsigtet anvendelse:

Personlig hygiejne

3. Fabrikant

Villeroy & Boch AG
Saarferstraße
66693 Mettlach
Tyskland

+49 (0) 68 64 / 8 10

information@villeroy-boch.com

www.villeroy-boch.com

4. Bemyndiget repræsentant

ikke relevant

5. System eller systemer til vurdering og kontrol af konstanden af ydeevnen

Dokumentation for ydeevne sker iht. System 4.

6. Harmoniseret standard & 7. Deklareret ydeevne/deklarerede ydeevner

Notificeret organ/notificerede organer - ikke relevant

væsentlige egenskaber	Ydeevne	Harmoniseret standard
Statisk modstandskraft (LR)	bestået	EN 14688:2006
Rengøring (CA)	bestået	EN 14688:2006
Belastningsmodstand (DA)	bestået	EN 14688:2006
Overløbets udledningsevne (OF)	bestået	EN 14688:2006

Ydeevnen for den vare, der er anført ovenfor, er i overensstemmelse med den deklarerede ydeevne. Denne ydeevnedeklaration er udarbejdet i overensstemmelse med forordning (EU) nr. 305/2011 på eneansvar af den fabrikant, der er anført ovenfor.

Underskrevet for fabrikanten og på dennes vegne af:

Mettlach, 18.1.2024

Sted og dato

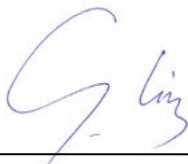

Underskrift

Georg Lörz
Bestyrelsesmedlem
Chef for virksomhedsområdet bad og wellness

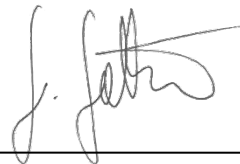

Underskrift

Giovanni Gattone
Teknisk chef/Head of Manufacturing

TOIMIVUSDEKLARATSIOON

Keel ET
Tölge

A113 - 0001

(Toote number, vt lisas olevat loendit)
Sisseehitatud valamud, süvispaigaldatud valamud, seinale
paigaldatavad valamud, valamud, tööpinnale
paigaldatavad valamud

1. Tootetüübi kordumatu identifitseerimiskood

Toodete loend asub lisas.

2. Kavandatud kasutusala(d)

isiklik hügieen

3. Tootja

Villeroy & Boch AG
Saarferstraße
66693 Mettlach
Saksamaa

+49 (0) 68 64 / 8 10
information@villeroy-boch.com
www.villeroy-boch.com

4. Volitatud esindaja

puudub

5. Toimivuse püsivuse hindamise ja kontrolli süsteem

Toimivustõend väljastatakse vastavalt süsteemile 4.

6. Ühtlustatud standard & 7. Deklareeritud toimivus

Teavitatud asutus(ed) - puudub

põhiomaduste	Toimivus	Ühtlustatud standard
Staatiline koormustaluvus (LR)	korras	EN 14688:2006
Puhtus (CA)	korras	EN 14688:2006
Vastupidavus (DA)	korras	EN 14688:2006
Ülevoolu äravooluväärtus (OF)	korras	EN 14688:2006

Toote toimivus vastab deklareeritud toimivusele / deklareeritud toimivustele. Toimivusdeklaratsiooni koostamise eest kooskõlas määrusega (EL) nr 305/2011 vastutab ainult ülalnimetatud tootja.

Tootja poolt ja nimel allkirjastanud:

Mettlach, 18.1.2024

Koht ja kuupäev

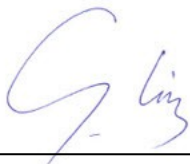

Allkiri

Georg Lörz
Juhatuse liige
Vannitoa ja heaolu valdkonna juhataja

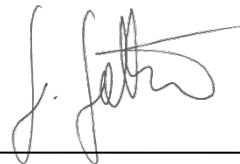

Allkiri

Giovanni Gattone
Tehniline juht / tootmisjuht

ΔΗΛΩΣΗ ΕΠΙΔΟΣΕΩΝ

Γλώσσα EL
Μετάφραση

A113 - 0001

(Αριθμός είδους βλέπε λίστα στο παράρτημα)

Ένθετοι νιπτήρες, υποκαθήμενοι νιπτήρες, επικαθήμενοι νιπτήρες άκρου, νιπτήρες, επικαθήμενοι νιπτήρες επίπλου

1. Μοναδικός κωδικός ταυτοποίησης του τύπου του προϊόντος

Η λίστα των προϊόντων βρίσκεται στο παράρτημα.

2. Προβλεπόμενη (-ες) χρήση (-εις)

προσωπική υγιεινή

3. Κατασκευαστής

Villeroy & Boch AG
Saaruferstraße
66693 Mettlach
Γερμανία

+49 (0) 68 64 / 8 10

information@villeroy-boch.com

www.villeroy-boch.com

4. Εξουσιοδοτημένος αντιπρόσωπος

δεν εφαρμόζεται

5. Σύστημα/συστήματα AVCP (αξιολόγηση και επαλήθευση της σταθερότητας της επίδοσης)

Η απόδειξη της επίδοσης πραγματοποιείται σύμφωνα με το σύστημα 4.

6. Εναρμονισμένα πρότυπα & 7. Δηλωθείσα(-ες) επίδοση(-εις)

Κοινοποιημένος(-οι) οργανισμός(-οι) - δεν εφαρμόζεται

Σημαντικά χαρακτηριστικά	Επίδοση	Εναρμονισμένα πρότυπα
στατική χωρητικότητα (LR)	επιτυχής	EN 14688:2006
Δυνατότητα καθαρισμού (CA)	επιτυχής	EN 14688:2006
Ανθεκτικότητα (DA)	επιτυχής	EN 14688:2006
Τμή απορροής της υπερχειλίσης (OF)	επιτυχής	EN 14688:2006

Η επίδοση του προϊόντος είναι σύμφωνη με τη (τις) δηλωθείσα(-ες) επίδοση(-εις). Η δήλωση αυτή των επιδόσεων συντάσσεται, σύμφωνα με τον κανονισμό (ΕΕ) αριθ. 305/2011, με αποκλειστική ευθύνη του κατασκευαστή που ταυτοποιείται ανωτέρω.

Υπογραφή για λογαριασμό και εξ ονόματος του κατασκευαστή από:

Mettlach, 18.1.2024

Τόπος και ημερομηνία

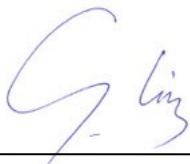

υπογραφή

Georg Lörz
Μέλος της διοίκησης
Διευθυντής του τμήματος λουτρών και Wellness

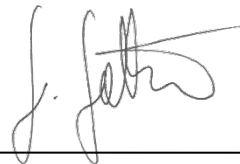

υπογραφή

Giovanni Gattone
Τεχνικός διευθυντής /Head of Manufacturing

SUORITUSTASOILMOITUS

Kieli FI
Käännös

A113 - 0001

(Tuotenumero, katso liitteen luettelo)

Tasoon upotettavat pesualtaat, tason alle asennettavat pesualtaat, tason eteen asennettavat pesualtaat, pesualtaat, tason päälle asennettavat pesualtaat

1. Tuotetyypin yksilöllinen tunnistus

Luettelo tuotteista on liitteessä.

2. Aiottu käyttötarkoitus (aiotut käyttötarkoitukset)

henkilökohtainen hygienia

3. Valmistaja

Villeroy & Boch AG
Saarferstraße
66693 Mettlach
Saksa

+49 (0) 68 64 / 8 10
information@villeroy-boch.com
www.villeroy-boch.com

4. Valtuutettu edustaja

ei sovellettavissa

5. Suoritustason pysyvyyden arvioinnissa ja varmentamisessa käytetty järjestelmä/käytetyt järjestelmät:

Suoritustasotodistus annetaan järjestelmän 4 mukaisesti.

6. Yhdenmukaistettu standardi & 7. Ilmoitettu suoritustaso / ilmoitetut suoritustasot

Ilmoitettu laitos/ilmoitetut laitokset: - ei sovellettavissa

Keskeiset ominaisuudet	Suoritustaso	Yhdenmukaistettu standardi
staattinen kuormitettavuus (LR)	hyväksytty	EN 14688:2006
Puhdistettavuus (CA)	hyväksytty	EN 14688:2006
Kestävyys (DA)	hyväksytty	EN 14688:2006
Ylivuodon virtaama (OF)	hyväksytty	EN 14688:2006

Tuotteen suoritustaso vastaa ilmoitettua suoritustasoa / ilmoitettuja suoritustasoja. Suoritustasoilmoituksen laatimisesta on asetuksen (EU) nro 305/2011 mukaisesti yllämainittu valmistaja yksin vastuussa.

Valmistajan puolesta allekirjoittanut:

Mettlach, 18.1.2024

Paikka ja aika

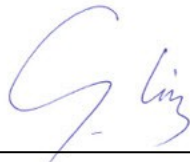

Allekirjoitus

Georg Lörz
Yritysjohdon jäsen
Kylpyhuone- ja wellness-osaston johtaja

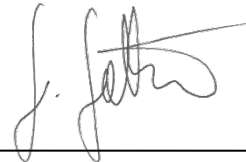

Allekirjoitus

Giovanni Gattone
Tekninen johtaja/Head of Manufacturing

IZJAVA O SVOJSTVIMA

Jezik HR
Prijevod

A113 - 0001

(za broj artikla vidi popis u prilogu)
Ugradbeni umivaonik, podgradni umivaonik, istureni
umivaonik, umivaonik, nadgradni umivaonik

1. Jedinstvena identifikacijska oznaka vrste proizvoda

Popis proizvoda nalazi se u prilogu.

2. Namjena/namjene

osobna higijena

3. Proizvođač

Villeroy & Boch AG
Saarferstraße
66693 Mettlach
Njemačka

+49 (0) 68 64 / 8 10
information@villeroy-boch.com
www.villeroy-boch.com

4. Ovlašteni predstavnik

nije primjenjivo

5. Sustav/sustavi za ocjenu i provjeru stalnosti svojstava (AVCP)

Dokaz o svojstvima temelji se na sustavu 4.

6. Uskladena norma & 7. Objavljena svojstva

Prijavljeno tijelo/prijavljena tijela - nije primjenjivo

Ključne značajke	Svojstvo	Uskladena norma
Statička nosivost (LR)	zadovoljeno	EN 14688:2006
Mogućnost čišćenja (CA)	zadovoljeno	EN 14688:2006
Trajnost (DA)	zadovoljeno	EN 14688:2006
Brzina protoka prelijevanja (OF)	zadovoljeno	EN 14688:2006

Prije utvrđeno svojstvo proizvoda u skladu je s objavljenim svojstvima. Ova izjava o svojstvima izdaje se, u skladu s Uredbom (EU) br. 305/2011, pod isključivom odgovornošću prethodno utvrđenog proizvođača.

Za proizvođača i u njegovo ime potpisao:

Mettlach, 18.1.2024

Mjesto i datum

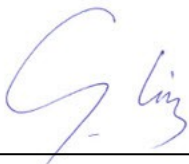

Potpis

Georg Lörz
Član Uprave
Voditelj Odjela za kupaonice i wellness

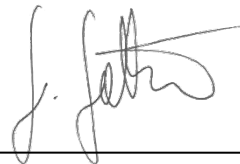

Potpis

Giovanni Gattone
Tehnički direktor / voditelj proizvodnje



EKSPLOATACINIŲ SAVYBIŲ DEKLARACIJA

Kalba LT
Vertimas

A113 - 0001

(Gaminio numerį žr. priedo sąrašė)
Integruojama kriauklė, įmontuojama kriauklė,
primontuojama kriauklė, kriauklė, pastatoma kriauklė

1. Produkto tipo unikalus identifikavimo kodas

Gaminių sąrašas pateikiamas priede.

2. Naudojimo paskirtis (-ys)

asmens higiena

3. Gamintojas

Villeroy & Boch AG
Saarferstraße
66693 Mettlach
Vokietija

+49 (0) 68 64 / 8 10

information@villeroy-boch.com

www.villeroy-boch.com

4. Įgaliotasis atstovas

nav piemērojams

5. Eksploatacinių savybių pastovumo vertinimo ir tikrinimo sistema (-os)

Eksploatacinės savybės patvirtinamos pagal 4 sistemą.

6. Darnusis standartas & Deklaruojama (-os) eksploatacinė (-ės) savybė (-ės)

Notifikuotoji (-osios) įstaiga (-os) - nav piemērojams

Svarbiausi požymiai	Eksploatacinė savybė	Darnusis standartas
statinė apkrova (LR)	išlaikyta	EN 14688:2006
Švaros palaikymas (CA)	išlaikyta	EN 14688:2006
Ilgamžiškumas (DA)	išlaikyta	EN 14688:2006
Perpildos nuvedimo vertė (OF)	išlaikyta	EN 14688:2006

Eksploatacinė gaminio savybė atitinka deklaruojamą eksploatacinę savybę / deklaruojamas eksploatacines savybes. Už eksploatacinių savybių deklaracijos parengimą pagal Reglamentą (ES) Nr. 305/2011 atsako tik pirmiau nurodytas gamintojas.

Pasirašyta (gamintojas ir jo vardu):

Mettlach, 18.1.2024

Vieta ir data

Parašas

Georg Lörz
Vadovybės narys
Vonios įrangos ir sveikatingumo skyriaus vadovas

Parašas

Giovanni Gattone
Techninis direktorius / Gamybos vadovas

EKSPLUATĀCIJAS ĪPAŠĪBU DEKLARĀCIJA

Valoda LV
Tulkojums

A113 - 0001

(Preces nr. skat pielikuma sarakstā)

Iebūvējamās izlietnes, pabūvējamās izlietnes, izlietnes ar izvirzītu priekšu, izlietnes, uz virsmas uzliedzamas izlietnes

1. Unikālais izstrādājuma tipa identifikācijas numurs

Produktu saraksts atrodams pielikumā.

2. Paredzētais izmantojums

Personiskā higiēna

3. Ražotājs

Villeroy & Boch AG
Saarferstraße
66693 Mettlach
Vācija

+49 (0) 68 64 / 8 10
information@villeroy-boch.com
www.villeroy-boch.com

4. Pilnvarotais pārstāvis

netaikoma

5. Eksploatācijas īpašību noturības novērtējuma un pārbaudes (AVCP) sistēma(-as)

Eksploatācijas īpašību pierādīšana tiek veikta saskaņā ar 4. sistēmu.

6. Saskaņotais standarts & 7. Deklarētā(-ās) eksploatācijas īpašība(-as)

Paziņotā(-ās) iestāde(-es) - netaikoma

Noteicošie rādītāji	eksploatācijas īpašības	Saskaņotais standarts
Statiskā kapacitāte (LR)	izturēts	EN 14688:2006
Tīrīšanas spēja (CA)	izturēts	EN 14688:2006
Izturība (DA)	izturēts	EN 14688:2006
pārplūdes novadišanas vērtība (OF)	izturēts	EN 14688:2006

Produkta eksploatācijas īpašības atbilst deklarētajām eksploatācijas īpašībām. Visu atbildību par snieguma deklarācijas sastādīšanu saskaņā ar Regulu (ES) Nr. 305/2011 uzņemas augstāk minētais ražotājs.

punktā norādītais ražotājs:

Mettlach, 18.1.2024

Vieta un datums

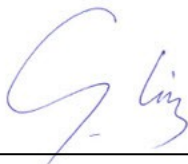

Paraksts

Georg Lörz
Valdes loceklis
Vannu un relaksācijas produktu nodaļas vadītājs

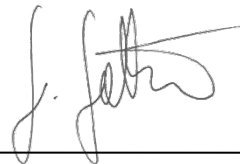

Paraksts

Giovanni Gattone
Tehniskais direktors / ražošanas vadītājs

YTELSESERKLÆRING

Språk NO
Oversettelse

A113 - 0001

(For artikkelnummer se liste i vedlegget)
Innfelt vaskeservant, undermontert vaskeservant,
toppmontert vaskeservant, vaskekum, toppmontert
vaskekum

1. Entydig ID-kode for produkttypen

Listen over produktene finner du i vedlegget.

2. Bruksområde(r)

Personlig hygiene

3. Produsent

Villeroy & Boch AG
Saarferstraße
66693 Mettlach
Tyskland

+49 (0) 68 64 / 8 10
information@villeroy-boch.com
www.villeroy-boch.com

4. Agent

Ikke aktuelt

5. System(er) til vurdering og kontroll av ytelsesbestandighet

Ytelsessertifikatet utstedes etter system 4.

6. Harmonisert standard & 7. Erklært ytelse

Varslet organ/er - Ikke aktuelt

Avgjørende kjennetegn	Effekt	Harmonisert standard
Statisk bæreevne (LR)	bestått	EN 14688:2006
Rengjøringsbarhet (CA)	bestått	EN 14688:2006
Holdbarhet (DA)	bestått	EN 14688:2006
Avløpsverdi for overløpet (OF)	bestått	EN 14688:2006

Ytelsen til produktet samsvarer med den erklærte ytelsen/de erklærte ytelsene. For oppretting av ytelseserklæringen i overensstemmelse med forordning (EU) nr. 305/2011 er utelukkende produsenten ovenfor ansvarlig.

Signert for og på vegne av produsenten av:

Mettlach, 18.1.2024

Sted og dato:

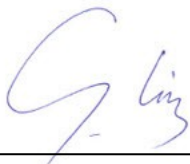

Signatur

Georg Lörz
Medlem i ledelsen
Leder for forretningsområdet bad og Wellness

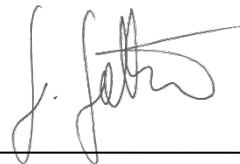

Signatur

Giovanni Gattone
Teknisk direktør/Head of Manufacturing



DECLARAÇÃO DE DESEMPENHO

Língua PT
Tradução

A113 - 0001

(Para o número de artigo, ver a lista no anexo)
Lavatórios de encastrar, lavatórios de encastrar por baixo,
lavatórios semiencastrados, lavatórios, lavatórios de
bancada

1. Código de identificação único do produto-tipo

A lista dos produtos encontra-se no anexo.

2. Utilização(ões) prevista(s)

higiene pessoal

3. Fabricante

Villeroy & Boch AG
Saaruferstraße
66693 Mettlach
Alemanha

+49 (0) 68 64 / 8 10
information@villeroy-boch.com
www.villeroy-boch.com

4. Mandatário

não se aplica

5. Sistema(s) de avaliação e verificação da regularidade do desempenho (AVCP)

A verificação do desempenho é realizada de acordo com o sistema 4.

6. Norma harmonizada & 7. Desempenho(s) declarado(s)

Organismo(s) notificado (s) - não se aplica

Características essenciais	Desempenho	Norma harmonizada
Resistência à carga (LR)	Aprovado	EN 14688:2006
Possibilidade de limpeza (CA)	Aprovado	EN 14688:2006
Durabilidade (DA)	Aprovado	EN 14688:2006
Valor de descarga do transbordo (OF)	Aprovado	EN 14688:2006

O desempenho do produto está em conformidade com o conjunto de desempenhos declarados. A presente declaração de desempenho é emitida, em conformidade com o Regulamento (UE) n.º 305/2011, sob a exclusiva responsabilidade do fabricante identificado acima.

Assinado por e em nome do fabricante:

Mettlach, 18.1.2024

Local e data

Assinatura

Georg Lörz
Membro do Conselho de Administração
Chefe da Divisão Casa de Banho e Spa

Assinatura

Giovanni Gattone
Diretor Técnico/Head of Manufacturing

DECLARAȚIE DE PERFORMANȚĂ

Limba RO
Traducere

A113 - 0001

(Vezi lista din anexă pentru numărul articolului)
Chiuveță încorporată, chiuveță încastrată, chiuveță cu
consolă, chiuveță, chiuveță exterioară

1. Cod unic de identificare al produsului-tip

Lista de produse se află în anexă.

2. Utilizare (utilizări) preconizată (preconizate)

igienă personală

3. Fabricant

Villeroy & Boch AG
Saarferstraße
66693 Mettlach
Germania

+49 (0) 68 64 / 8 10

information@villeroy-boch.com

www.villeroy-boch.com

4. Reprezentant autorizat

nu se aplică

5. Sistemul (sistemele) de evaluare și de verificare a constanței performanței

Dovada performanței este realizată conform sistemului 4.

6. Standard armonizat & 7. Performanța (performanțe) declarată (declarate)

Organism (organisme) notificat(e) - nu se aplică

Caracteristică esențială	Performanță	Standard armonizat
Capacitate de încărcare statică (LR)	îndeplinit	EN 14688:2006
Curățare (CA)	îndeplinit	EN 14688:2006
Durabilitate (DA)	îndeplinit	EN 14688:2006
Coeficient de scurgere preaplin (OF)	îndeplinit	EN 14688:2006

Performanța produsului corespunde performanței/permanțelor declarate. Pentru întocmirea declarației de performanță în conformitate cu Regulamentul (UE) nr. 305/2011 este responsabil exclusiv producătorul menționat.

Semnată pentru și în numele fabricantului de către:

Mettlach, 18.1.2024

localitate și dată

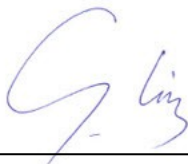

Semnătură

Georg Lörz
Membru al conducerii
Directorul departamentului Baie și wellness

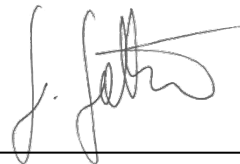

Semnătură

Giovanni Gattone
Director tehnic/Head of Manufacturing

IZJAVA O LASTNOSTIH

Jezik SL
Prevod

A113 - 0001

(Za številko izdelka glejte seznam v prilogi)
Vgradni umivalnik, podpultni umivalnik, predpultni umivalnik, umivalnik, nadpultni umivalnik

1. Enotna identifikacijska oznaka tipa proizvoda

Seznam izdelkov je naveden v prilogi.

2. Predvidena uporaba

osebna higiena

3. Proizvajalec

Villeroy & Boch AG
Saarferstraße
66693 Mettlach
Nemčija

+49 (0) 68 64 / 8 10
information@villeroy-boch.com
www.villeroy-boch.com

4. Pooblaščen zastopnik

se ne uporablja

5. Sistemi ocenjevanja in preverjanja nespremenljivosti lastnosti

Dokazilo o lastnostih je v skladu s sistemom 4.

6. Harmonizirani standard & 7. Navedene lastnosti:

Priglašeni organi - se ne uporablja

Odločilne značilnosti	Lastnost	Harmonizirani standard
Statična obremenljivost (LR)	opravljeno	EN 14688:2006
Čistost (CA)	opravljeno	EN 14688:2006
Trajnost (DA)	opravljeno	EN 14688:2006
Odtočna vrednost preliva (OF)	opravljeno	EN 14688:2006

Lastnost izdelka ustreza navedeni lastnosti/navedenim lastnostim. Za izdelavo izjave o lastnostih v skladu z Uredbo (EU) št. 305/2011 je odgovoren samo prej navedeni proizvajalec.

Podpisal za in v imenu proizvajalca:

Mettlach, 18.1.2024

Kraj in datum

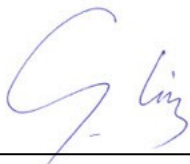

Podpis

Georg Lörz
Član uprave
Vodja oddelka za kopalnice in wellness

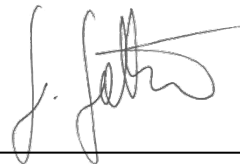

Podpis

Giovanni Gattone
Tehnični direktor/vodja proizvodnje

PRESTANDEDEKLARATION

Språk SV
Översättning

A113 - 0001

(Artikelnummer, se lista i bilagan)

Inbyggt tvättställ, undermonterat tvättställ, frontmonterat tvättställ, tvättställ, ovanpåliggande tvättställ

1. Produkttypens unika identifikationskod

Listan över produkter finns i bilagan.

2. Avsedd användning/avsedda användningar

personlig hygien

3. Tillverkare

Villeroy & Boch AG
Saaruferstraße
66693 Mettlach
Tyskland

+49 (0) 68 64 / 8 10
information@villeroy-boch.com
www.villeroy-boch.com

4. Tillverkarens representant

inte tillämpligt

5. System för bedömning och fortlöpande kontroll av prestanda

Bevis om prestanda sker enligt system 4.

6. Harmoniserad standard & 7. Angiven prestanda

Anmält/anmälda organ - inte tillämpligt

Utmärkande drag	prestanda	Harmoniserad standard
statisk styrka (LR)	uppfyller	EN 14688:2006
Rengörbarhet (CA)	uppfyller	EN 14688:2006
Beständighet (DA)	uppfyller	EN 14688:2006
Utloppsvärde för bräddavlopp (OF)	uppfyller	EN 14688:2006

Prestandan för ovanstående produkt överensstämmer med den angivna prestandan. Denna prestandadeklaration har utfärdats i enlighet med förordning (EU) nr 305/2011 på eget ansvar av den tillverkare som anges ovan.

Undertecknat för tillverkaren av:

Mettlach, 18.1.2024

Ort och datum

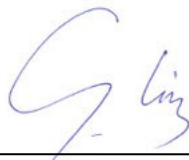

Namnteckning

Georg Lörz
Styrelseledamot
Chef för divisionen bad och wellness

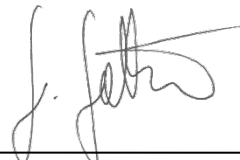

Namnteckning

Giovanni Gattone
Teknisk chef/Head of Manufacturing

KAPASITE BEYANI

Dil TR
Tercüme

A113 - 0001

(Ürün numarası için ekteki listeye bakınız)
Tezgah üstü lavabo, tezgah altı lavabo, etajerli lavabo,
lavabo, çanak lavabo

1. Ürün tipinin benzersiz tanım kodu
Ürünlerin listesi ektedir.

2. Kullanım amacı (amaçları)
kişisel hijyen

3. Üretici

Villeroy & Boch AG
Saarferstraße
66693 Mettlach
Almanya

+49 (0) 68 64 / 8 10
information@villeroy-boch.com
www.villeroy-boch.com

4. Temsilci

belirtilmiyor

5. Kapasite dayanımının değerlendirilmesi ve kontrolü için sistem (sistemler)
Kapasite ispatı, Sistem 4'e göre gerçekleşir.

6. Uyumlaştırılmış Standart ve 7. Beyan edilen kapasite (kapasiteler)

Onaylanmış kuruluş/kuruluşlar - belirtilmiyor

Belirleyici özellikler	Kapasite	Uyumlaştırılmış Standart
statik yüklenebilirlik (LR)	geçti	EN 14688:2006
Temizlenebilirlik (CA)	geçti	EN 14688:2006
Dayanıklılık (DA)	geçti	EN 14688:2006
Taşma giderinin akış değeri (OF)	geçti	EN 14688:2006

Ürünün kapasitesi, beyan edilen kapasiteye/kapasitelere uygundur. Kapasite beyanının 305/2011 sayılı düzenleme (AB) ile uyum için hazırlanmasından, tek başına yukarıda belirtilen üretici sorumludur.

Üretici adına ve adına imzalayan:

Mettlach, 18.1.2024

Yer ve tarih

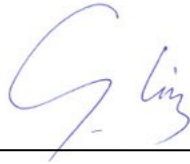

İmza

Georg Lörz
Yönetim kurulu üyesi
Banyo ve Wellness bölümünün yöneticisi

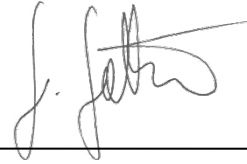

İmza

Giovanni Gattone
Teknik direktör/Üretim müdürü

Model-No.	Collection	CE Marking
41043T	VENTICELLO	EN 14688:2006 CL 25 OF-CA-LR-DA
41048J	VENTICELLO	EN 14688:2006 CL 25 OF-CA-LR-DA
41048L	VENTICELLO	EN 14688:2006 CL 25 OF-CA-LR-DA
4104AJ	VENTICELLO	EN 14688:2006 CL 25 OF-CA-LR-DA
4104AK	VENTICELLO	EN 14688:2006 CL 25 OF-CA-LR-DA
4104AL	VENTICELLO	EN 14688:2006 CL 25 OF-CA-LR-DA
4104CH	VENTICELLO	EN 14688:2006 CL00 OF-CA-LR-DA
4104CJ	VENTICELLO	EN 14688:2006 CL 25 OF-CA-LR-DA
4104CK	VENTICELLO	EN 14688:2006 CL 25 OF-CA-LR-DA
4104CL	VENTICELLO	EN 14688:2006 CL 25 OF-CA-LR-DA
4104U1	VENTICELLO	EN 14688:2006 CL 25 OF-CA-LR-DA
4104U2	VENTICELLO	EN 14688:2006 CL 25 OF-CA-LR-DA
4104U3	VENTICELLO	EN 14688:2006 CL 25 OF-CA-LR-DA
4104U4	VENTICELLO	EN 14688:2006 CL 25 OF-CA-LR-DA
4104U5	VENTICELLO	EN 14688:2006 CL 25 OF-CA-LR-DA
4104U6	VENTICELLO	EN 14688:2006 CL 25 OF-CA-LR-DA
411060	MY NATURE	EN 14688:2006 CL00 OF-CA-LR-DA
411080	MY NATURE	EN 14688:2006 CL00 OF-CA-LR-DA

Model-No.	Collection	CE Marking
4111DG	VENTICELLO	EN 14688:2006 CL00 OF-CA-LR-DA
4111DJ	VENTICELLO	EN 14688:2006 CL 25 OF-CA-LR-DA
4111DL	VENTICELLO	EN 14688:2006 CL 25 OF-CA-LR-DA
4111U4	VENTICELLO	EN 14688:2006 CL 25 OF-CA-LR-DA
4111UA	VENTICELLO	EN 14688:2006 CL 25 OF-CA-LR-DA
411355	VENTICELLO	EN 14688:2006 CL 25 OF-CA-LR-DA
41156R	SUBWAY 2.0	EN 14688:2006 CL00 OF-CA-LR-DA
411955	VICARE	EN 14688:2006 CL 25 OF-CA-LR-DA
411956	VICARE	EN 14688:2006 CL00 OF-CA-LR-DA
411960	VICARE	EN 14688:2006 CL 25 OF-CA-LR-DA
411961	VICARE	EN 14688:2006 CL00 OF-CA-LR-DA
411963	VICARE	EN 14688:2006 CL00 OF-CA-LR-DA
412080	VICARE	EN 14688:2006 CL 25 OF-CA-LR-DA
412081	VICARE	EN 14688:2006 CL00 OF-CA-LR-DA
41243T	VENTICELLO	EN 14688:2006 CL 25 OF-CA-LR-DA
412450	VENTICELLO	EN 14688:2006 CL 25 OF-CA-LR-DA
412460	VENTICELLO	EN 14688:2006 CL 25 OF-CA-LR-DA
412462	VENTICELLO	EN 14688:2006 CL 25 OF-CA-LR-DA
412465	VENTICELLO	EN 14688:2006 CL 25 OF-CA-LR-DA

Model-No.	Collection	CE Marking
412467	VENTICELLO	EN 14688:2006 CL 25 OF-CA-LR-DA
4124G6	VENTICELLO	EN 14688:2006 CL 25 OF-CA-LR-DA
4124U1	VENTICELLO	EN 14688:2006 CL 25 OF-CA-LR-DA
4124U2	VENTICELLO	EN 14688:2006 CL 25 OF-CA-LR-DA
412540	ARCHITECTURA	EN 14688:2006 CL 25 OF-CA-LR-DA
412541	ARCHITECTURA	EN 14688:2006 CL00 OF-CA-LR-DA
412660	ARCHITECTURA	EN 14688:2006 CL 25 OF-CA-LR-DA
412661	ARCHITECTURA	EN 14688:2006 CL00 OF-CA-LR-DA
412760	ARCHITECTURA	EN 14688:2006 CL 25 OF-CA-LR-DA
412761	ARCHITECTURA	EN 14688:2006 CL 25 OF-CA-LR-DA
413355	MEMENTO	EN 14688:2006 CL 25 OF-CA-LR-DA
4134L1	VENTICELLO	EN 14688:2006 CL 25 OF-CA-LR-DA
4134L3	VENTICELLO	EN 14688:2006 CL 25 OF-CA-LR-DA
4134R1	VENTICELLO	EN 14688:2006 CL 25 OF-CA-LR-DA
4134R3	VENTICELLO	EN 14688:2006 CL 25 OF-CA-LR-DA
413848	LUNEA	EN 14688:2006 CL 25 OF-CA-LR-DA
4139DK	FINION	EN 14688:2006 CL 25 OF-CA-LR-DA
414261	FINION	EN 14688:2006 CL00 OF-CA-LR-DA
414264	FINION	EN 14688:2006 CL00 OF-CA-LR-DA

Model-No.	Collection	CE Marking
414361	FINION	EN 14688:2006 CL00 OF-CA-LR-DA
4150D4	LEGATO	EN 14688:2006 CL 25 OF-CA-LR-DA
415160	LEGATO	EN 14688:2006 CL 25 OF-CA-LR-DA
415250	TUBE	EN 14688:2006 CL 25 OF-CA-LR-DA
4153A2	LEGATO	EN 14688:2006 CL00 OF-CA-LR-DA
4153C4	LEGATO	EN 14688:2006 CL 25 OF-CA-LR-DA
415680	AVENTO	EN 14688:2006 CL 25 OF-CA-LR-DA
415681	AVENTO	EN 14688:2006 CL00 OF-CA-LR-DA
4156A1	AVENTO	EN 14688:2006 CL00 OF-CA-LR-DA
4156A2	AVENTO	EN 14688:2006 CL00 OF-CA-LR-DA
4156A4	AVENTO	EN 14688:2006 CL 25 OF-CA-LR-DA
4156A5	AVENTO	EN 14688:2006 CL 25 OF-CA-LR-DA
4156U1	AVENTO	EN 14688:2006 CL 25 OF-CA-LR-DA
4156U8	AVENTO	EN 14688:2006 CL 25 OF-CA-LR-DA
415860	AVENTO	EN 14688:2006 CL 25 OF-CA-LR-DA
415865	AVENTO	EN 14688:2006 CL 25 OF-CA-LR-DA
415866	AVENTO	EN 14688:2006 CL00 OF-CA-LR-DA
4158U6	AVENTO	EN 14688:2006 CL 25 OF-CA-LR-DA
416055	O.NOVO	EN 14688:2006 CL 25 OF-CA-LR-DA

Model-No.	Collection	CE Marking
416056	O.NOVO	EN 14688:2006 CL00 OF-CA-LR-DA
416156	O.NOVO	EN 14688:2006 CL 25 OF-CA-LR-DA
416157	O.NOVO	EN 14688:2006 CL00 OF-CA-LR-DA
416250	O.NOVO	EN 14688:2006 CL 25 OF-CA-LR-DA
416260	O.NOVO	EN 14688:2006 CL 25 OF-CA-LR-DA
4162U5	O.NOVO	EN 14688:2006 CL 25 OF-CA-LR-DA
416480	FINION	EN 14688:2006 CL 25 OF-CA-LR-DA
416481	FINION	EN 14688:2006 CL00 OF-CA-LR-DA
416483	FINION	EN 14688:2006 CL00 OF-CA-LR-DA
416484	FINION	EN 14688:2006 CL00 OF-CA-LR-DA
4164A1	FINION	EN 14688:2006 CL00 OF-CA-LR-DA
4164A2	FINION	EN 14688:2006 CL00 OF-CA-LR-DA
4164A3	FINION	EN 14688:2006 CL00 OF-CA-LR-DA
4164AB	FINION	EN 14688:2006 CL00 OF-CA-LR-DA
4164C1	FINION	EN 14688:2006 CL00 OF-CA-LR-DA
4164C2	FINION	EN 14688:2006 CL00 OF-CA-LR-DA
4164C3	FINION	EN 14688:2006 CL00 OF-CA-LR-DA
4164C5	FINION	EN 14688:2006 CL 25 OF-CA-LR-DA
4164CB	FINION	EN 14688:2006 CL00 OF-CA-LR-DA

Model-No.	Collection	CE Marking
416540	ARCHITECTURA	EN 14688:2006 CL 25 OF-CA-LR-DA
416660	ARCHITECTURA	EN 14688:2006 CL 25 OF-CA-LR-DA
416661	ARCHITECTURA	EN 14688:2006 CL 25 OF-CA-LR-DA
416760	ARCHITECTURA	EN 14688:2006 CL 25 OF-CA-LR-DA
416761	ARCHITECTURA	EN 14688:2006 CL 25 OF-CA-LR-DA
41681B	FINION	EN 14688:2006 CL00 OF-CA-LR-DA
41681H	FINION	EN 14688:2006 CL00 OF-CA-LR-DA
41681L	FINION	EN 14688:2006 CL00 OF-CA-LR-DA
416860	FINION	EN 14688:2006 CL 25 OF-CA-LR-DA
416861	FINION	EN 14688:2006 CL00 OF-CA-LR-DA
416864	FINION	EN 14688:2006 CL00 OF-CA-LR-DA
41686C	FINION	EN 14688:2006 CL00 OF-CA-LR-DA
41686L	FINION	EN 14688:2006 CL00 OF-CA-LR-DA
416880	FINION	EN 14688:2006 CL 25 OF-CA-LR-DA
416881	FINION	EN 14688:2006 CL00 OF-CA-LR-DA
416884	FINION	EN 14688:2006 CL00 OF-CA-LR-DA
41688C	FINION	EN 14688:2006 CL00 OF-CA-LR-DA
41688L	FINION	EN 14688:2006 CL00 OF-CA-LR-DA
4168A1	FINION	EN 14688:2006 CL00 OF-CA-LR-DA

Model-No.	Collection	CE Marking
4168A2	FINION	EN 14688:2006 CL00 OF-CA-LR-DA
4168AB	FINION	EN 14688:2006 CL00 OF-CA-LR-DA
417000	OCTAGON	EN 14688:2006 CL00 OF-CA-LR-DA
417040	OCTAGON	EN 14688:2006 CL00 OF-CA-LR-DA
417258	ARTIS	EN 14688:2006 CL00 OF-CA-LR-DA
4172U5	ARTIS	EN 14688:2006 CL00 OF-CA-LR-DA
417540	ARCHITECTURA	EN 14688:2006 CL 25 OF-CA-LR-DA
417660	ARCHITECTURA	EN 14688:2006 CL 25 OF-CA-LR-DA
417661	ARCHITECTURA	EN 14688:2006 CL00 OF-CA-LR-DA
417760	ARCHITECTURA	EN 14688:2006 CL 25 OF-CA-LR-DA
417761	ARCHITECTURA	EN 14688:2006 CL00 OF-CA-LR-DA
4177U6	ARCHITECTURA	EN 14688:2006 CL 25 OF-CA-LR-DA
417841	ARTIS	EN 14688:2006 CL00 OF-CA-LR-DA
4178U4	ARTIS	EN 14688:2006 CL00 OF-CA-LR-DA
417943	ARTIS	EN 14688:2006 CL00 OF-CA-LR-DA
4179U4	ARTIS	EN 14688:2006 CL00 OF-CA-LR-DA
418855	ARCHITECTURA	EN 14688:2006 CL 25 OF-CA-LR-DA
418856	ARCHITECTURA	EN 14688:2006 CL 25 OF-CA-LR-DA
41885G	ARCHITECTURA	EN 14688:2006 CL 25 OF-CA-LR-DA

Model-No.	Collection	CE Marking
418860	ARCHITECTURA	EN 14688:2006 CL 25 OF-CA-LR-DA
418861	ARCHITECTURA	EN 14688:2006 CL00 OF-CA-LR-DA
418865	ARCHITECTURA	EN 14688:2006 CL 25 OF-CA-LR-DA
418866	ARCHITECTURA	EN 14688:2006 CL00 OF-CA-LR-DA
41886G	ARCHITECTURA	EN 14688:2006 CL 25 OF-CA-LR-DA
4188KG	ARCHITECTURA	EN 14688:2006 CL 25 OF-CA-LR-DA
419055	ARCHITECTURA	EN 14688:2006 CL 25 OF-CA-LR-DA
419056	ARCHITECTURA	EN 14688:2006 CL 25 OF-CA-LR-DA
419355	ARCHITECTURA	EN 14688:2006 CL 25 OF-CA-LR-DA
419356	ARCHITECTURA	EN 14688:2006 CL00 OF-CA-LR-DA
419861	ARTIS	EN 14688:2006 CL00 OF-CA-LR-DA
4198U6	ARTIS	EN 14688:2006 CL00 OF-CA-LR-DA
43003L	AVENTO	EN 14688:2006 CL00 OF-CA-LR-DA
43003R	AVENTO	EN 14688:2006 CL00 OF-CA-LR-DA
43163L	NEWO	EN 14688:2006 CL 25 OF-CA-LR-DA
43163R	NEWO	EN 14688:2006 CL 25 OF-CA-LR-DA
432340	MEMENTO 2.0	EN 14688:2006 CL00 OF-CA-LR-DA
43234G	MEMENTO 2.0	EN 14688:2006 CL00 OF-CA-LR-DA
4323U4	MEMENTO 2.0	EN 14688:2006 CL00 OF-CA-LR-DA

Model-No.	Collection	CE Marking
4323UM	MEMENTO 2.0	EN 14688:2006 CL00 OF-CA-LR-DA
433445	COLLARO	EN 14688:2006 CL 15 OF-CA-LR-DA
433446	COLLARO	EN 14688:2006 CL00 OF-CA-LR-DA
433450	COLLARO	EN 14688:2006 CL 15 OF-CA-LR-DA
433451	COLLARO	EN 14688:2006 CL00 OF-CA-LR-DA
43345G	COLLARO	EN 14688:2006 CL 15 OF-CA-LR-DA
434036	O.NOVO	EN 14688:2006 CL 25 OF-CA-LR-DA
434037	O.NOVO	EN 14688:2006 CL00 OF-CA-LR-DA
43403L	O.NOVO	EN 14688:2006 CL 25 OF-CA-LR-DA
43403R	O.NOVO	EN 14688:2006 CL 25 OF-CA-LR-DA
434045	O.NOVO	EN 14688:2006 CL 25 OF-CA-LR-DA
434046	O.NOVO	EN 14688:2006 CL00 OF-CA-LR-DA
434050	O.NOVO	EN 14688:2006 CL 25 OF-CA-LR-DA
434051	O.NOVO	EN 14688:2006 CL 25 OF-CA-LR-DA
434236	O.NOVO SQUARE	EN 14688:2006 CL 25 OF-CA-LR-DA
434237	O.NOVO SQUARE	EN 14688:2006 CL00 OF-CA-LR-DA
434252	O.NOVO SQUARE	EN 14688:2006 CL 25 OF-CA-LR-DA
434253	O.NOVO SQUARE	EN 14688:2006 CL00 OF-CA-LR-DA
4342L5	O.NOVO SQUARE	EN 14688:2006 CL 25 OF-CA-LR-DA

Model-No.	Collection	CE Marking
4342R5	O.NOVO SQUARE	EN 14688:2006 CL 25 OF-CA-LR-DA
434336	O.NOVO SQUARE	EN 14688:2006 CL 25 OF-CA-LR-DA
434337	O.NOVO SQUARE	EN 14688:2006 CL00 OF-CA-LR-DA
434445	O.NOVO SQUARE	EN 14688:2006 CL 25 OF-CA-LR-DA
434446	O.NOVO SQUARE	EN 14688:2006 CL00 OF-CA-LR-DA
434447	O.NOVO SQUARE	EN 14688:2006 CL 25 OF-CA-LR-DA
434448	O.NOVO SQUARE	EN 14688:2006 CL00 OF-CA-LR-DA
43444F	O.NOVO SQUARE	EN 14688:2006 CL00 OF-CA-LR-DA
43444G	O.NOVO SQUARE	EN 14688:2006 CL 25 OF-CA-LR-DA
43444J	O.NOVO SQUARE	EN 14688:2006 CL 25 OF-CA-LR-DA
43444L	O.NOVO SQUARE	EN 14688:2006 CL00 OF-CA-LR-DA
434450	O.NOVO SQUARE	EN 14688:2006 CL 25 OF-CA-LR-DA
434451	O.NOVO SQUARE	EN 14688:2006 CL00 OF-CA-LR-DA
434452	O.NOVO SQUARE	EN 14688:2006 CL 25 OF-CA-LR-DA
434453	O.NOVO SQUARE	EN 14688:2006 CL00 OF-CA-LR-DA
435150	LEGATO	EN 14688:2006 CL 25 OF-CA-LR-DA
436443	FINION	EN 14688:2006 CL00 OF-CA-LR-DA
436444	FINION	EN 14688:2006 CL00 OF-CA-LR-DA
43644C	FINION	EN 14688:2006 CL 25 OF-CA-LR-DA

Model-No.	Collection	CE Marking
43644L	FINION	EN 14688:2006 CL00 OF-CA-LR-DA
437037	SUBWAY 3.0	EN 14688:2006 CL 25 OF-CA-LR-DA
437038	SUBWAY 3.0	EN 14688:2006 CL00 OF-CA-LR-DA
437045	SUBWAY 3.0	EN 14688:2006 CL 25 OF-CA-LR-DA
437046	SUBWAY 3.0	EN 14688:2006 CL00 OF-CA-LR-DA
437050	SUBWAY 3.0	EN 14688:2006 CL 25 OF-CA-LR-DA
437051	SUBWAY 3.0	EN 14688:2006 CL00 OF-CA-LR-DA
4370FF	SUBWAY 3.0	EN 14688:2006 CL 25 OF-CA-LR-DA
4370FG	SUBWAY 3.0	EN 14688:2006 CL00 OF-CA-LR-DA
4370FK	SUBWAY 3.0	EN 14688:2006 CL 25 OF-CA-LR-DA
4370FL	SUBWAY 3.0	EN 14688:2006 CL00 OF-CA-LR-DA
437146	SUBWAY 3.0	EN 14688:2006 CL00 OF-CA-LR-DA
437336	ARCHITECTURA	EN 14688:2006 CL 25 OF-CA-LR-DA
437337	ARCHITECTURA	EN 14688:2006 CL00 OF-CA-LR-DA
437345	ARCHITECTURA	EN 14688:2006 CL 25 OF-CA-LR-DA
437346	ARCHITECTURA	EN 14688:2006 CL00 OF-CA-LR-DA
437350	ARCHITECTURA	EN 14688:2006 CL 25 OF-CA-LR-DA
437351	ARCHITECTURA	EN 14688:2006 CL00 OF-CA-LR-DA
438848	ARTIS	EN 14688:2006 CL00 OF-CA-LR-DA

Model-No.	Collection	CE Marking
438932	ARTIS	EN 14688:2006 CL00 OF-CA-LR-DA
439145	NEWO	EN 14688:2006 CL 25 OF-CA-LR-DA
439245	NEWO	EN 14688:2006 CL 25 OF-CA-LR-DA
439250	NEWO	EN 14688:2006 CL 25 OF-CA-LR-DA
439350	NEWO	EN 14688:2006 CL 25 OF-CA-LR-DA
43935L	NEWO	EN 14688:2006 CL 25 OF-CA-LR-DA
43935R	NEWO	EN 14688:2006 CL 25 OF-CA-LR-DA
43944L	NEWO	EN 14688:2006 CL 25 OF-CA-LR-DA
43944R	NEWO	EN 14688:2006 CL 25 OF-CA-LR-DA
4A0055	AVENTO	EN 14688:2006 CL 25 OF-CA-LR-DA
4A0056	AVENTO	EN 14688:2006 CL00 OF-CA-LR-DA
4A00U5	AVENTO	EN 14688:2006 CL 25 OF-CA-LR-DA
4A0160	LABELLE	EN 14688:2006 CL 25 OF-CA-LR-DA
4A0161	LABELLE	EN 14688:2006 CL00 OF-CA-LR-DA
4A0655	AVENTO	EN 14688:2006 CL 25 OF-CA-LR-DA
4A0750	MEMENTO 2.0	EN 14688:2006 CL 25 OF-CA-LR-DA
4A0751	MEMENTO 2.0	EN 14688:2006 CL00 OF-CA-LR-DA
4A0760	MEMENTO 2.0	EN 14688:2006 CL 25 OF-CA-LR-DA
4A0761	MEMENTO 2.0	EN 14688:2006 CL00 OF-CA-LR-DA

Model-No.	Collection	CE Marking
4A07U5	MEMENTO 2.0	EN 14688:2006 CL 25 OF-CA-LR-DA
4A07U6	MEMENTO 2.0	EN 14688:2006 CL 25 OF-CA-LR-DA
4A07UB	MEMENTO 2.0	EN 14688:2006 CL 25 OF-CA-LR-DA
4A07UC	MEMENTO 2.0	EN 14688:2006 CL 25 OF-CA-LR-DA
4A0813	O.NOVO KIDS	EN 14688:2006 CL00 OF-CA-LR-DA
4A09A2	ANTHEUS	EN 14688:2006 CL00 OF-CA-LR-DA
4A09A5	ANTHEUS	EN 14688:2006 CL 25 OF-CA-LR-DA
4A1065	ANTHEUS	EN 14688:2006 CL00 OF-CA-LR-DA
4A13UA	ARCHITECTURA	EN 14688:2006 CL 25 OF-CA-LR-DA
4A1551	COLLARO	EN 14688:2006 CL00 OF-CA-LR-DA
4A1751	COLLARO	EN 14688:2006 CL00 OF-CA-LR-DA
4A1753	COLLARO	EN 14688:2006 CL00 OF-CA-LR-DA
4A1840	COLLARO	EN 14688:2006 CL00 OF-CA-LR-DA
4A1956	COLLARO	EN 14688:2006 CL00 OF-CA-LR-DA
4A2056	COLLARO	EN 14688:2006 CL00 OF-CA-LR-DA
4A2138	COLLARO	EN 14688:2006 CL00 OF-CA-LR-DA
4A221F	MEMENTO 2.0	EN 14688:2006 CL00 OF-CA-LR-DA
4A221G	MEMENTO 2.0	EN 14688:2006 CL 25 OF-CA-LR-DA
4A221H	MEMENTO 2.0	EN 14688:2006 CL00 OF-CA-LR-DA

Model-No.	Collection	CE Marking
4A221K	MEMENTO 2.0	EN 14688:2006 CL00 OF-CA-LR-DA
4A221L	MEMENTO 2.0	EN 14688:2006 CL 25 OF-CA-LR-DA
4A2250	MEMENTO 2.0	EN 14688:2006 CL 25 OF-CA-LR-DA
4A2251	MEMENTO 2.0	EN 14688:2006 CL00 OF-CA-LR-DA
4A2253	MEMENTO 2.0	EN 14688:2006 CL00 OF-CA-LR-DA
4A225F	MEMENTO 2.0	EN 14688:2006 CL00 OF-CA-LR-DA
4A225G	MEMENTO 2.0	EN 14688:2006 CL 25 OF-CA-LR-DA
4A225L	MEMENTO 2.0	EN 14688:2006 CL00 OF-CA-LR-DA
4A2260	MEMENTO 2.0	EN 14688:2006 CL 25 OF-CA-LR-DA
4A2261	MEMENTO 2.0	EN 14688:2006 CL00 OF-CA-LR-DA
4A2263	MEMENTO 2.0	EN 14688:2006 CL00 OF-CA-LR-DA
4A226F	MEMENTO 2.0	EN 14688:2006 CL00 OF-CA-LR-DA
4A226G	MEMENTO 2.0	EN 14688:2006 CL 25 OF-CA-LR-DA
4A226L	MEMENTO 2.0	EN 14688:2006 CL00 OF-CA-LR-DA
4A2280	MEMENTO 2.0	EN 14688:2006 CL 25 OF-CA-LR-DA
4A2281	MEMENTO 2.0	EN 14688:2006 CL00 OF-CA-LR-DA
4A2283	MEMENTO 2.0	EN 14688:2006 CL00 OF-CA-LR-DA
4A228F	MEMENTO 2.0	EN 14688:2006 CL00 OF-CA-LR-DA
4A228G	MEMENTO 2.0	EN 14688:2006 CL 25 OF-CA-LR-DA

Model-No.	Collection	CE Marking
4A228L	MEMENTO 2.0	EN 14688:2006 CL00 OF-CA-LR-DA
4A22A1	MEMENTO 2.0	EN 14688:2006 CL00 OF-CA-LR-DA
4A22A2	MEMENTO 2.0	EN 14688:2006 CL00 OF-CA-LR-DA
4A22A3	MEMENTO 2.0	EN 14688:2006 CL00 OF-CA-LR-DA
4A22A4	MEMENTO 2.0	EN 14688:2006 CL 25 OF-CA-LR-DA
4A22A5	MEMENTO 2.0	EN 14688:2006 CL 25 OF-CA-LR-DA
4A22C1	MEMENTO 2.0	EN 14688:2006 CL00 OF-CA-LR-DA
4A22C2	MEMENTO 2.0	EN 14688:2006 CL00 OF-CA-LR-DA
4A22C3	MEMENTO 2.0	EN 14688:2006 CL00 OF-CA-LR-DA
4A22C4	MEMENTO 2.0	EN 14688:2006 CL 25 OF-CA-LR-DA
4A22C5	MEMENTO 2.0	EN 14688:2006 CL 25 OF-CA-LR-DA
4A22CF	MEMENTO 2.0	EN 14688:2006 CL00 OF-CA-LR-DA
4A22CG	MEMENTO 2.0	EN 14688:2006 CL00 OF-CA-LR-DA
4A22CH	MEMENTO 2.0	EN 14688:2006 CL00 OF-CA-LR-DA
4A22CK	MEMENTO 2.0	EN 14688:2006 CL 25 OF-CA-LR-DA
4A22CL	MEMENTO 2.0	EN 14688:2006 CL 25 OF-CA-LR-DA
4A22U0	MEMENTO 2.0	EN 14688:2006 CL 25 OF-CA-LR-DA
4A22U1	MEMENTO 2.0	EN 14688:2006 CL 25 OF-CA-LR-DA
4A22U2	MEMENTO 2.0	EN 14688:2006 CL 25 OF-CA-LR-DA

Model-No.	Collection	CE Marking
4A22U5	MEMENTO 2.0	EN 14688:2006 CL 25 OF-CA-LR-DA
4A22U6	MEMENTO 2.0	EN 14688:2006 CL 25 OF-CA-LR-DA
4A22U8	MEMENTO 2.0	EN 14688:2006 CL 25 OF-CA-LR-DA
4A22U9	MEMENTO 2.0	EN 14688:2006 CL 25 OF-CA-LR-DA
4A22UB	MEMENTO 2.0	EN 14688:2006 CL 25 OF-CA-LR-DA
4A22UC	MEMENTO 2.0	EN 14688:2006 CL 25 OF-CA-LR-DA
4A22UF	MEMENTO 2.0	EN 14688:2006 CL 25 OF-CA-LR-DA
4A22UG	MEMENTO 2.0	EN 14688:2006 CL 25 OF-CA-LR-DA
4A22UH	MEMENTO 2.0	EN 14688:2006 CL 25 OF-CA-LR-DA
4A22UJ	MEMENTO 2.0	EN 14688:2006 CL 25 OF-CA-LR-DA
4A22UL	MEMENTO 2.0	EN 14688:2006 CL 25 OF-CA-LR-DA
4A22UN	MEMENTO 2.0	EN 14688:2006 CL 25 OF-CA-LR-DA
4A22UP	MEMENTO 2.0	EN 14688:2006 CL 25 OF-CA-LR-DA
4A22UQ	MEMENTO 2.0	EN 14688:2006 CL 25 OF-CA-LR-DA
4A22UR	MEMENTO 2.0	EN 14688:2006 CL 25 OF-CA-LR-DA
4A22US	MEMENTO 2.0	EN 14688:2006 CL 25 OF-CA-LR-DA
4A22UT	MEMENTO 2.0	EN 14688:2006 CL 25 OF-CA-LR-DA
4A22UU	MEMENTO 2.0	EN 14688:2006 CL 25 OF-CA-LR-DA
4A22UV	MEMENTO 2.0	EN 14688:2006 CL 25 OF-CA-LR-DA

Model-No.	Collection	CE Marking
4A23CG	AVENTO	EN 14688:2006 CL00 OF-CA-LR-DA
4A23CK	AVENTO	EN 14688:2006 CL 25 OF-CA-LR-DA
4A331G	COLLARO	EN 14688:2006 CL 25 OF-CA-LR-DA
4A3355	COLLARO	EN 14688:2006 CL 25 OF-CA-LR-DA
4A3356	COLLARO	EN 14688:2006 CL00 OF-CA-LR-DA
4A3358	COLLARO	EN 14688:2006 CL00 OF-CA-LR-DA
4A3360	COLLARO	EN 14688:2006 CL 25 OF-CA-LR-DA
4A3361	COLLARO	EN 14688:2006 CL00 OF-CA-LR-DA
4A3363	COLLARO	EN 14688:2006 CL00 OF-CA-LR-DA
4A3365	COLLARO	EN 14688:2006 CL 25 OF-CA-LR-DA
4A3366	COLLARO	EN 14688:2006 CL00 OF-CA-LR-DA
4A3368	COLLARO	EN 14688:2006 CL00 OF-CA-LR-DA
4A336G	COLLARO	EN 14688:2006 CL 25 OF-CA-LR-DA
4A3380	COLLARO	EN 14688:2006 CL 25 OF-CA-LR-DA
4A3381	COLLARO	EN 14688:2006 CL00 OF-CA-LR-DA
4A3383	COLLARO	EN 14688:2006 CL00 OF-CA-LR-DA
4A338G	COLLARO	EN 14688:2006 CL 25 OF-CA-LR-DA
4A33A2	COLLARO	EN 14688:2006 CL00 OF-CA-LR-DA
4A33A3	COLLARO	EN 14688:2006 CL00 OF-CA-LR-DA

Model-No.	Collection	CE Marking
4A33A5	COLLARO	EN 14688:2006 CL 25 OF-CA-LR-DA
4A33C1	COLLARO	EN 14688:2006 CL00 OF-CA-LR-DA
4A33C2	COLLARO	EN 14688:2006 CL00 OF-CA-LR-DA
4A33C3	COLLARO	EN 14688:2006 CL00 OF-CA-LR-DA
4A33C4	COLLARO	EN 14688:2006 CL 25 OF-CA-LR-DA
4A33C5	COLLARO	EN 14688:2006 CL 25 OF-CA-LR-DA
4A34D1	COLLARO	EN 14688:2006 CL00 OF-CA-LR-DA
4A34D2	COLLARO	EN 14688:2006 CL00 OF-CA-LR-DA
4A34D4	COLLARO	EN 14688:2006 CL 25 OF-CA-LR-DA
4A4055	O.NOVO	EN 14688:2006 CL 25 OF-CA-LR-DA
4A4056	O.NOVO	EN 14688:2006 CL00 OF-CA-LR-DA
4A4057	O.NOVO	EN 14688:2006 CL 25 OF-CA-LR-DA
4A4058	O.NOVO	EN 14688:2006 CL00 OF-CA-LR-DA
4A4060	O.NOVO	EN 14688:2006 CL 25 OF-CA-LR-DA
4A4061	O.NOVO	EN 14688:2006 CL00 OF-CA-LR-DA
4A4062	O.NOVO	EN 14688:2006 CL 25 OF-CA-LR-DA
4A4063	O.NOVO	EN 14688:2006 CL00 OF-CA-LR-DA
4A4065	O.NOVO	EN 14688:2006 CL 25 OF-CA-LR-DA
4A4066	O.NOVO	EN 14688:2006 CL00 OF-CA-LR-DA

Model-No.	Collection	CE Marking
4A4155	O.NOVO SQUARE	EN 14688:2006 CL 25 OF-CA-LR-DA
4A4156	O.NOVO SQUARE	EN 14688:2006 CL00 OF-CA-LR-DA
4A4157	O.NOVO SQUARE	EN 14688:2006 CL00 OF-CA-LR-DA
4A4158	O.NOVO SQUARE	EN 14688:2006 CL00 OF-CA-LR-DA
4A4160	O.NOVO SQUARE	EN 14688:2006 CL 25 OF-CA-LR-DA
4A4161	O.NOVO SQUARE	EN 14688:2006 CL00 OF-CA-LR-DA
4A4162	O.NOVO SQUARE	EN 14688:2006 CL 25 OF-CA-LR-DA
4A4163	O.NOVO SQUARE	EN 14688:2006 CL00 OF-CA-LR-DA
4A4165	O.NOVO SQUARE	EN 14688:2006 CL 25 OF-CA-LR-DA
4A4166	O.NOVO SQUARE	EN 14688:2006 CL00 OF-CA-LR-DA
4A4167	O.NOVO SQUARE	EN 14688:2006 CL 25 OF-CA-LR-DA
4A4168	O.NOVO SQUARE	EN 14688:2006 CL00 OF-CA-LR-DA
4A416F	O.NOVO SQUARE	EN 14688:2006 CL00 OF-CA-LR-DA
4A416G	O.NOVO SQUARE	EN 14688:2006 CL 25 OF-CA-LR-DA
4A416J	O.NOVO SQUARE	EN 14688:2006 CL 25 OF-CA-LR-DA
4A416L	O.NOVO SQUARE	EN 14688:2006 CL00 OF-CA-LR-DA
4A41KF	O.NOVO SQUARE	EN 14688:2006 CL00 OF-CA-LR-DA
4A41KG	O.NOVO SQUARE	EN 14688:2006 CL 25 OF-CA-LR-DA
4A41KJ	O.NOVO SQUARE	EN 14688:2006 CL 25 OF-CA-LR-DA

Model-No.	Collection	CE Marking
4A41KL	O.NOVO SQUARE	EN 14688:2006 CL00 OF-CA-LR-DA
4A41MF	O.NOVO SQUARE	EN 14688:2006 CL00 OF-CA-LR-DA
4A41MG	O.NOVO SQUARE	EN 14688:2006 CL 25 OF-CA-LR-DA
4A41MJ	O.NOVO SQUARE	EN 14688:2006 CL00 OF-CA-LR-DA
4A41ML	O.NOVO SQUARE	EN 14688:2006 CL 25 OF-CA-LR-DA
4A4500	LOOP AND FRIENDS	EN 14688:2006 CL 25 OF-CA-LR-DA
4A4501	LOOP AND FRIENDS	EN 14688:2006 CL00 OF-CA-LR-DA
4A4600	LOOP AND FRIENDS	EN 14688:2006 CL 25 OF-CA-LR-DA
4A4601	LOOP AND FRIENDS	EN 14688:2006 CL00 OF-CA-LR-DA
4A4700	LOOP AND FRIENDS	EN 14688:2006 CL 25 OF-CA-LR-DA
4A4701	LOOP AND FRIENDS	EN 14688:2006 CL00 OF-CA-LR-DA
4A4800	LOOP AND FRIENDS	EN 14688:2006 CL 25 OF-CA-LR-DA
4A4801	LOOP AND FRIENDS	EN 14688:2006 CL00 OF-CA-LR-DA
4A4900	LOOP AND FRIENDS	EN 14688:2006 CL 25 OF-CA-LR-DA
4A4901	LOOP AND FRIENDS	EN 14688:2006 CL00 OF-CA-LR-DA
4A5000	LOOP AND FRIENDS	EN 14688:2006 CL 25 OF-CA-LR-DA
4A5001	LOOP AND FRIENDS	EN 14688:2006 CL00 OF-CA-LR-DA
4A5100	LOOP AND FRIENDS	EN 14688:2006 CL 25 OF-CA-LR-DA
4A5101	LOOP AND FRIENDS	EN 14688:2006 CL00 OF-CA-LR-DA

Model-No.	Collection	CE Marking
4A5200	LOOP AND FRIENDS	EN 14688:2006 CL 25 OF-CA-LR-DA
4A5201	LOOP AND FRIENDS	EN 14688:2006 CL00 OF-CA-LR-DA
4A5300	LOOP AND FRIENDS	EN 14688:2006 CL 25 OF-CA-LR-DA
4A5301	LOOP AND FRIENDS	EN 14688:2006 CL00 OF-CA-LR-DA
4A5400	LOOP AND FRIENDS	EN 14688:2006 CL 25 OF-CA-LR-DA
4A5401	LOOP AND FRIENDS	EN 14688:2006 CL00 OF-CA-LR-DA
4A5500	LOOP AND FRIENDS	EN 14688:2006 CL 25 OF-CA-LR-DA
4A5501	LOOP AND FRIENDS	EN 14688:2006 CL00 OF-CA-LR-DA
4A5600	LOOP AND FRIENDS	EN 14688:2006 CL 25 OF-CA-LR-DA
4A5601	LOOP AND FRIENDS	EN 14688:2006 CL00 OF-CA-LR-DA
4A5700	LOOP AND FRIENDS	EN 14688:2006 CL 25 OF-CA-LR-DA
4A5701	LOOP AND FRIENDS	EN 14688:2006 CL00 OF-CA-LR-DA
4A5800	LOOP AND FRIENDS	EN 14688:2006 CL 25 OF-CA-LR-DA
4A5801	LOOP AND FRIENDS	EN 14688:2006 CL00 OF-CA-LR-DA
4A5900	LOOP AND FRIENDS	EN 14688:2006 CL 25 OF-CA-LR-DA
4A5901	LOOP AND FRIENDS	EN 14688:2006 CL00 OF-CA-LR-DA
4A6000	LOOP AND FRIENDS	EN 14688:2006 CL 25 OF-CA-LR-DA
4A6001	LOOP AND FRIENDS	EN 14688:2006 CL00 OF-CA-LR-DA
4A6100	LOOP AND FRIENDS	EN 14688:2006 CL 25 OF-CA-LR-DA

Model-No.	Collection	CE Marking
4A6101	LOOP AND FRIENDS	EN 14688:2006 CL00 OF-CA-LR-DA
4A6200	LOOP AND FRIENDS	EN 14688:2006 CL 25 OF-CA-LR-DA
4A6201	LOOP AND FRIENDS	EN 14688:2006 CL00 OF-CA-LR-DA
4A6300	LOOP AND FRIENDS	EN 14688:2006 CL 25 OF-CA-LR-DA
4A6301	LOOP AND FRIENDS	EN 14688:2006 CL00 OF-CA-LR-DA
4A6400	LOOP AND FRIENDS	EN 14688:2006 CL 25 OF-CA-LR-DA
4A6401	LOOP AND FRIENDS	EN 14688:2006 CL00 OF-CA-LR-DA
4A6500	LOOP AND FRIENDS	EN 14688:2006 CL 25 OF-CA-LR-DA
4A6501	LOOP AND FRIENDS	EN 14688:2006 CL00 OF-CA-LR-DA
4A6600	LOOP AND FRIENDS	EN 14688:2006 CL 25 OF-CA-LR-DA
4A6601	LOOP AND FRIENDS	EN 14688:2006 CL00 OF-CA-LR-DA
4A6760	NEWO	EN 14688:2006 CL 25 OF-CA-LR-DA
4A6860	VICARE	EN 14688:2006 CL 25 OF-CA-LR-DA
4A6861	VICARE	EN 14688:2006 CL00 OF-CA-LR-DA
4A6862	VICARE	EN 14688:2006 CL 25 OF-CA-LR-DA
4A6863	VICARE	EN 14688:2006 CL00 OF-CA-LR-DA
4A6880	VICARE	EN 14688:2006 CL 25 OF-CA-LR-DA
4A6881	VICARE	EN 14688:2006 CL00 OF-CA-LR-DA
4A6882	VICARE	EN 14688:2006 CL 25 OF-CA-LR-DA

Model-No.	Collection	CE Marking
4A6883	VICARE	EN 14688:2006 CL00 OF-CA-LR-DA
4A7055	SUBWAY 3.0	EN 14688:2006 CL 25 OF-CA-LR-DA
4A7056	SUBWAY 3.0	EN 14688:2006 CL00 OF-CA-LR-DA
4A7057	SUBWAY 3.0	EN 14688:2006 CL 25 OF-CA-LR-DA
4A7058	SUBWAY 3.0	EN 14688:2006 CL00 OF-CA-LR-DA
4A7060	SUBWAY 3.0	EN 14688:2006 CL 25 OF-CA-LR-DA
4A7061	SUBWAY 3.0	EN 14688:2006 CL00 OF-CA-LR-DA
4A7062	SUBWAY 3.0	EN 14688:2006 CL 25 OF-CA-LR-DA
4A7063	SUBWAY 3.0	EN 14688:2006 CL00 OF-CA-LR-DA
4A7065	SUBWAY 3.0	EN 14688:2006 CL 25 OF-CA-LR-DA
4A7066	SUBWAY 3.0	EN 14688:2006 CL00 OF-CA-LR-DA
4A7067	SUBWAY 3.0	EN 14688:2006 CL 25 OF-CA-LR-DA
4A7068	SUBWAY 3.0	EN 14688:2006 CL00 OF-CA-LR-DA
4A706F	SUBWAY 3.0	EN 14688:2006 CL00 OF-CA-LR-DA
4A706G	SUBWAY 3.0	EN 14688:2006 CL 25 OF-CA-LR-DA
4A706J	SUBWAY 3.0	EN 14688:2006 CL 25 OF-CA-LR-DA
4A706L	SUBWAY 3.0	EN 14688:2006 CL00 OF-CA-LR-DA
4A7080	SUBWAY 3.0	EN 14688:2006 CL 25 OF-CA-LR-DA
4A7081	SUBWAY 3.0	EN 14688:2006 CL00 OF-CA-LR-DA

Model-No.	Collection	CE Marking
4A7082	SUBWAY 3.0	EN 14688:2006 CL 25 OF-CA-LR-DA
4A7083	SUBWAY 3.0	EN 14688:2006 CL00 OF-CA-LR-DA
4A70A2	SUBWAY 3.0	EN 14688:2006 CL00 OF-CA-LR-DA
4A70A3	SUBWAY 3.0	EN 14688:2006 CL00 OF-CA-LR-DA
4A70A5	SUBWAY 3.0	EN 14688:2006 CL 25 OF-CA-LR-DA
4A70A6	SUBWAY 3.0	EN 14688:2006 CL 25 OF-CA-LR-DA
4A70D1	SUBWAY 3.0	EN 14688:2006 CL00 OF-CA-LR-DA
4A70D2	SUBWAY 3.0	EN 14688:2006 CL00 OF-CA-LR-DA
4A70D3	SUBWAY 3.0	EN 14688:2006 CL00 OF-CA-LR-DA
4A70D4	SUBWAY 3.0	EN 14688:2006 CL 25 OF-CA-LR-DA
4A70D5	SUBWAY 3.0	EN 14688:2006 CL 25 OF-CA-LR-DA
4A70D6	SUBWAY 3.0	EN 14688:2006 CL 25 OF-CA-LR-DA
4A70F4	SUBWAY 3.0	EN 14688:2006 CL 25 OF-CA-LR-DA
4A70F5	SUBWAY 3.0	EN 14688:2006 CL00 OF-CA-LR-DA
4A70F6	SUBWAY 3.0	EN 14688:2006 CL00 OF-CA-LR-DA
4A70F7	SUBWAY 3.0	EN 14688:2006 CL 25 OF-CA-LR-DA
4A71D1	SUBWAY 3.0	EN 14688:2006 CL00 OF-CA-LR-DA
4A71D3	SUBWAY 3.0	EN 14688:2006 CL00 OF-CA-LR-DA
4A71D5	SUBWAY 3.0	EN 14688:2006 CL 25 OF-CA-LR-DA

Model-No.	Collection	CE Marking
4A71D6	SUBWAY 3.0	EN 14688:2006 CL 25 OF-CA-LR-DA
4A7240	ANTAO	EN 14688:2006 CL00 OF-CA-LR-DA
4A7351	ANTAO	EN 14688:2006 CL00 OF-CA-LR-DA
4A7465	ANTAO	EN 14688:2006 CL00 OF-CA-LR-DA
4A7581	ANTAO	EN 14688:2006 CL00 OF-CA-LR-DA
4A7583	ANTAO	EN 14688:2006 CL 25 OF-CA-LR-DA
4A7584	ANTAO	EN 14688:2006 CL 25 OF-CA-LR-DA
4A76A2	ANTAO	EN 14688:2006 CL 25 OF-CA-LR-DA
4A76A3	ANTAO	EN 14688:2006 CL 25 OF-CA-LR-DA
4A76AB	ANTAO	EN 14688:2006 CL 25 OF-CA-LR-DA
4A88F4	V&B EXCLUSIVE MAIN	EN 14688:2006 CL 25 OF-CA-LR-DA
4A9155	NEWO	EN 14688:2006 CL 25 OF-CA-LR-DA
4A9160	NEWO	EN 14688:2006 CL 25 OF-CA-LR-DA
4A9165	NEWO	EN 14688:2006 CL 25 OF-CA-LR-DA
4A9255	NEWO	EN 14688:2006 CL 25 OF-CA-LR-DA
4A9260	NEWO	EN 14688:2006 CL 25 OF-CA-LR-DA
4A9265	NEWO	EN 14688:2006 CL 25 OF-CA-LR-DA
512050	LUNEA	EN 14688:2006 CL 25 OF-CA-LR-DA
512253	LUNEA	EN 14688:2006 CL 25 OF-CA-LR-DA

Model-No.	Collection	CE Marking
513350	MEMENTO	EN 14688:2006 CL 25 OF-CA-LR-DA
513353	MEMENTO	EN 14688:2006 CL00 OF-CA-LR-DA
51335L	MEMENTO	EN 14688:2006 CL 25 OF-CA-LR-DA
513360	MEMENTO	EN 14688:2006 CL 25 OF-CA-LR-DA
51336L	MEMENTO	EN 14688:2006 CL 25 OF-CA-LR-DA
513385	MEMENTO	EN 14688:2006 CL 25 OF-CA-LR-DA
51338L	MEMENTO	EN 14688:2006 CL 25 OF-CA-LR-DA
5133A4	MEMENTO	EN 14688:2006 CL 25 OF-CA-LR-DA
5133AK	MEMENTO	EN 14688:2006 CL 25 OF-CA-LR-DA
513550	MEMENTO	EN 14688:2006 CL 25 OF-CA-LR-DA
513560	MEMENTO	EN 14688:2006 CL 25 OF-CA-LR-DA
514400	LOOP AND FRIENDS	EN 14688:2006 CL 25 OF-CA-LR-DA
514401	LOOP AND FRIENDS	EN 14688:2006 CL00 OF-CA-LR-DA
514800	LOOP AND FRIENDS	EN 14688:2006 CL 25 OF-CA-LR-DA
514801	LOOP AND FRIENDS	EN 14688:2006 CL00 OF-CA-LR-DA
514901	LOOP AND FRIENDS	EN 14688:2006 CL00 OF-CA-LR-DA
514910	LOOP AND FRIENDS	EN 14688:2006 CL 25 OF-CA-LR-DA
515100	LOOP AND FRIENDS	EN 14688:2006 CL 25 OF-CA-LR-DA
515101	LOOP AND FRIENDS	EN 14688:2006 CL00 OF-CA-LR-DA

Model-No.	Collection	CE Marking
515110	LOOP AND FRIENDS	EN 14688:2006 CL 25 OF-CA-LR-DA
515111	LOOP AND FRIENDS	EN 14688:2006 CL00 OF-CA-LR-DA
515400	LOOP AND FRIENDS	EN 14688:2006 CL 25 OF-CA-LR-DA
515401	LOOP AND FRIENDS	EN 14688:2006 CL00 OF-CA-LR-DA
516055	O.NOVO	EN 14688:2006 CL 25 OF-CA-LR-DA
516056	O.NOVO	EN 14688:2006 CL00 OF-CA-LR-DA
516058	O.NOVO	EN 14688:2006 CL00 OF-CA-LR-DA
516060	O.NOVO	EN 14688:2006 CL 25 OF-CA-LR-DA
516061	O.NOVO	EN 14688:2006 CL00 OF-CA-LR-DA
516065	O.NOVO	EN 14688:2006 CL 25 OF-CA-LR-DA
516066	O.NOVO	EN 14688:2006 CL00 OF-CA-LR-DA
5160S1	O.NOVO	EN 14688:2006 CL 25 OF-CA-LR-DA
516655	O.NOVO	EN 14688:2006 CL 25 OF-CA-LR-DA
517560	ARCHITECTURA	EN 14688:2006 CL 25 OF-CA-LR-DA
517655	ARCHITECTURA	EN 14688:2006 CL 25 OF-CA-LR-DA
517860	VICARE	EN 14688:2006 CL 25 OF-CA-LR-DA
517865	VICARE	EN 14688:2006 CL 25 OF-CA-LR-DA
517867	VICARE	EN 14688:2006 CL 25 OF-CA-LR-DA
517868	VICARE	EN 14688:2006 CL00 OF-CA-LR-DA

Model-No.	Collection	CE Marking
519511	METRIC ART	EN 14688:2006 CL00 OF-CA-LR-DA
533341	MEMENTO	EN 14688:2006 CL00 OF-CA-LR-DA
536036	O.NOVO	EN 14688:2006 CL 25 OF-CA-LR-DA
536037	O.NOVO	EN 14688:2006 CL00 OF-CA-LR-DA
536038	O.NOVO	EN 14688:2006 CL 25 OF-CA-LR-DA
536039	O.NOVO	EN 14688:2006 CL 25 OF-CA-LR-DA
536045	O.NOVO	EN 14688:2006 CL 25 OF-CA-LR-DA
536046	O.NOVO	EN 14688:2006 CL00 OF-CA-LR-DA
536050	O.NOVO	EN 14688:2006 CL 25 OF-CA-LR-DA
536051	O.NOVO	EN 14688:2006 CL00 OF-CA-LR-DA
536150	O.NOVO	EN 14688:2006 CL 25 OF-CA-LR-DA
536151	O.NOVO	EN 14688:2006 CL00 OF-CA-LR-DA
536153	O.NOVO	EN 14688:2006 CL 25 OF-CA-LR-DA
536154	O.NOVO	EN 14688:2006 CL 25 OF-CA-LR-DA
5A2545	ARCHITECTURA	EN 14688:2006 CL 25 OF-CA-LR-DA
5A2546	ARCHITECTURA	EN 14688:2006 CL00 OF-CA-LR-DA
5A2660	ARCHITECTURA	EN 14688:2006 CL 25 OF-CA-LR-DA
5A2661	ARCHITECTURA	EN 14688:2006 CL00 OF-CA-LR-DA
5A2760	ARCHITECTURA	EN 14688:2006 CL 25 OF-CA-LR-DA

Model-No.	Collection	CE Marking
5A2761	ARCHITECTURA	EN 14688:2006 CL00 OF-CA-LR-DA
5A3241	CONUM	EN 14688:2006 CL00 OF-CA-LR-DA
5A3343	CONUM	EN 14688:2006 CL00 OF-CA-LR-DA
5A6545	ARCHITECTURA	EN 14688:2006 CL 25 OF-CA-LR-DA
5A6546	ARCHITECTURA	EN 14688:2006 CL00 OF-CA-LR-DA
5A6660	ARCHITECTURA	EN 14688:2006 CL 25 OF-CA-LR-DA
5A6661	ARCHITECTURA	EN 14688:2006 CL00 OF-CA-LR-DA
5A6760	ARCHITECTURA	EN 14688:2006 CL 25 OF-CA-LR-DA
5A6761	ARCHITECTURA	EN 14688:2006 CL00 OF-CA-LR-DA
5A7545	ARCHITECTURA	EN 14688:2006 CL 25 OF-CA-LR-DA
5A7546	ARCHITECTURA	EN 14688:2006 CL00 OF-CA-LR-DA
5A7660	ARCHITECTURA	EN 14688:2006 CL 25 OF-CA-LR-DA
5A7661	ARCHITECTURA	EN 14688:2006 CL00 OF-CA-LR-DA
5A7760	ARCHITECTURA	EN 14688:2006 CL 25 OF-CA-LR-DA
5A7761	ARCHITECTURA	EN 14688:2006 CL00 OF-CA-LR-DA
611610	ARCHITECTURA	EN 14688:2006 CL 25 OF-CA-LR-DA
611680	ARCHITECTURA	EN 14688:2006 CL 25 OF-CA-LR-DA
614039	LOOP AND FRIENDS	EN 14688:2006 CL 25 OF-CA-LR-DA
614045	LOOP AND FRIENDS	EN 14688:2006 CL 25 OF-CA-LR-DA

Model-No.	Collection	CE Marking
6140U0	LOOP AND FRIENDS	EN 14688:2006 CL 25 OF-CA-LR-DA
6140U1	LOOP AND FRIENDS	EN 14688:2006 CL 25 OF-CA-LR-DA
614400	EVANA	EN 14688:2006 CL 25 OF-CA-LR-DA
6144U0	EVANA	EN 14688:2006 CL 25 OF-CA-LR-DA
614500	LOOP AND FRIENDS	EN 14688:2006 CL 25 OF-CA-LR-DA
614510	LOOP AND FRIENDS	EN 14688:2006 CL 25 OF-CA-LR-DA
614520	LOOP AND FRIENDS	EN 14688:2006 CL 25 OF-CA-LR-DA
6145U0	LOOP AND FRIENDS	EN 14688:2006 CL 25 OF-CA-LR-DA
6145U1	LOOP AND FRIENDS	EN 14688:2006 CL 25 OF-CA-LR-DA
614700	EVANA	EN 14688:2006 CL 25 OF-CA-LR-DA
614746	EVANA	EN 14688:2006 CL 25 OF-CA-LR-DA
6147U0	EVANA	EN 14688:2006 CL 25 OF-CA-LR-DA
6147U1	EVANA	EN 14688:2006 CL 25 OF-CA-LR-DA
615510	LOOP AND FRIENDS	EN 14688:2006 CL 25 OF-CA-LR-DA
615520	LOOP AND FRIENDS	EN 14688:2006 CL 25 OF-CA-LR-DA
615530	LOOP AND FRIENDS	EN 14688:2006 CL 25 OF-CA-LR-DA
6155U0	LOOP AND FRIENDS	EN 14688:2006 CL 25 OF-CA-LR-DA
6155U1	LOOP AND FRIENDS	EN 14688:2006 CL 25 OF-CA-LR-DA
616110	LOOP AND FRIENDS	EN 14688:2006 CL 25 OF-CA-LR-DA

Model-No.	Collection	CE Marking
616111	LOOP AND FRIENDS	EN 14688:2006 CL00 OF-CA-LR-DA
616120	LOOP AND FRIENDS	EN 14688:2006 CL 25 OF-CA-LR-DA
616121	LOOP AND FRIENDS	EN 14688:2006 CL00 OF-CA-LR-DA
616130	LOOP AND FRIENDS	EN 14688:2006 CL 25 OF-CA-LR-DA
616131	LOOP AND FRIENDS	EN 14688:2006 CL00 OF-CA-LR-DA
6161U1	LOOP AND FRIENDS	EN 14688:2006 CL 25 OF-CA-LR-DA
6161U2	LOOP AND FRIENDS	EN 14688:2006 CL 25 OF-CA-LR-DA
6161U3	LOOP AND FRIENDS	EN 14688:2006 CL 25 OF-CA-LR-DA
616220	LOOP AND FRIENDS	EN 14688:2006 CL 25 OF-CA-LR-DA
616300	LOOP AND FRIENDS	EN 14688:2006 CL 25 OF-CA-LR-DA
616301	LOOP AND FRIENDS	EN 14688:2006 CL00 OF-CA-LR-DA
616310	LOOP AND FRIENDS	EN 14688:2006 CL 25 OF-CA-LR-DA
616311	LOOP AND FRIENDS	EN 14688:2006 CL00 OF-CA-LR-DA
616320	LOOP AND FRIENDS	EN 14688:2006 CL 25 OF-CA-LR-DA
616321	LOOP AND FRIENDS	EN 14688:2006 CL00 OF-CA-LR-DA
6163U0	LOOP AND FRIENDS	EN 14688:2006 CL 25 OF-CA-LR-DA
6163U1	LOOP AND FRIENDS	EN 14688:2006 CL 25 OF-CA-LR-DA
6163U2	LOOP AND FRIENDS	EN 14688:2006 CL 25 OF-CA-LR-DA
618028	LOOP AND FRIENDS	EN 14688:2006 CL 25 OF-CA-LR-DA

Model-No.	Collection	CE Marking
618033	LOOP AND FRIENDS	EN 14688:2006 CL 25 OF-CA-LR-DA
618038	LOOP AND FRIENDS	EN 14688:2006 CL 25 OF-CA-LR-DA
6180U1	LOOP AND FRIENDS	EN 14688:2006 CL 25 OF-CA-LR-DA
6180U2	LOOP AND FRIENDS	EN 14688:2006 CL 25 OF-CA-LR-DA
618133	LOOP AND FRIENDS	EN 14688:2006 CL00 OF-CA-LR-DA
618138	LOOP AND FRIENDS	EN 14688:2006 CL00 OF-CA-LR-DA
710175	HOMMAGE	EN 14688:2006 CL 25 OF-CA-LR-DA
7101A1	HOMMAGE	EN 14688:2006 CL 25 OF-CA-LR-DA
710263	HOMMAGE	EN 14688:2006 CL 25 OF-CA-LR-DA
7102A1	HOMMAGE	EN 14688:2006 CL 25 OF-CA-LR-DA
711355	SUBWAY 2.0	EN 14688:2006 CL 25 OF-CA-LR-DA
711360	SUBWAY 2.0	EN 14688:2006 CL 25 OF-CA-LR-DA
711361	SUBWAY 2.0	EN 14688:2006 CL00 OF-CA-LR-DA
711362	SUBWAY 2.0	EN 14688:2006 CL 25 OF-CA-LR-DA
711365	SUBWAY 2.0	EN 14688:2006 CL 25 OF-CA-LR-DA
71136G	SUBWAY 2.0	EN 14688:2006 CL 25 OF-CA-LR-DA
7113F0	SUBWAY 2.0	EN 14688:2006 CL 25 OF-CA-LR-DA
7113F5	SUBWAY 2.0	EN 14688:2006 CL 25 OF-CA-LR-DA
7113FA	SUBWAY 2.0	EN 14688:2006 CL 25 OF-CA-LR-DA

Model-No.	Collection	CE Marking
7113KG	SUBWAY 2.0	EN 14688:2006 CL 25 OF-CA-LR-DA
7113U0	SUBWAY	EN 14688:2006 CL 25 OF-CA-LR-DA
7113U1	SUBWAY	EN 14688:2006 CL 25 OF-CA-LR-DA
7113U2	SUBWAY	EN 14688:2006 CL 25 OF-CA-LR-DA
7113U3	SUBWAY	EN 14688:2006 CL 25 OF-CA-LR-DA
711961	VICARE	EN 14688:2006 CL00 OF-CA-LR-DA
711963	VICARE	EN 14688:2006 CL 25 OF-CA-LR-DA
71751G	SUBWAY 2.0	EN 14688:2006 CL 25 OF-CA-LR-DA
717580	SUBWAY 2.0	EN 14688:2006 CL 25 OF-CA-LR-DA
71758G	SUBWAY 2.0	EN 14688:2006 CL 25 OF-CA-LR-DA
7175A0	SUBWAY 2.0	EN 14688:2006 CL 25 OF-CA-LR-DA
7175A1	SUBWAY 2.0	EN 14688:2006 CL00 OF-CA-LR-DA
7175D0	SUBWAY 2.0	EN 14688:2006 CL 25 OF-CA-LR-DA
7175D1	SUBWAY 2.0	EN 14688:2006 CL00 OF-CA-LR-DA
7175U0	SUBWAY	EN 14688:2006 CL 25 OF-CA-LR-DA
7175U1	SUBWAY	EN 14688:2006 CL 25 OF-CA-LR-DA
7175U2	SUBWAY	EN 14688:2006 CL 25 OF-CA-LR-DA
7175U3	SUBWAY	EN 14688:2006 CL 25 OF-CA-LR-DA
7175U4	SUBWAY	EN 14688:2006 CL 25 OF-CA-LR-DA

Model-No.	Collection	CE Marking
7175UA	SUBWAY	EN 14688:2006 CL 25 OF-CA-LR-DA
7176D0	SUBWAY 2.0	EN 14688:2006 CL 25 OF-CA-LR-DA
7176D2	SUBWAY 2.0	EN 14688:2006 CL 25 OF-CA-LR-DA
7176D3	SUBWAY 2.0	EN 14688:2006 CL00 OF-CA-LR-DA
7176U0	SUBWAY	EN 14688:2006 CL 25 OF-CA-LR-DA
731032	O.NOVO	EN 14688:2006 CL 15 OF-CA-LR-DA
731033	O.NOVO	EN 14688:2006 CL00 OF-CA-LR-DA
731545	SUBWAY 2.0	EN 14688:2006 CL 25 OF-CA-LR-DA
731550	SUBWAY 2.0	EN 14688:2006 CL 25 OF-CA-LR-DA
73155G	SUBWAY 2.0	EN 14688:2006 CL 25 OF-CA-LR-DA
7315F0	SUBWAY 2.0	EN 14688:2006 CL 25 OF-CA-LR-DA
7315F5	SUBWAY 2.0	EN 14688:2006 CL 25 OF-CA-LR-DA
7315U0	SUBWAY	EN 14688:2006 CL 25 OF-CA-LR-DA
731737	SUBWAY 2.0	EN 14688:2006 CL 25 OF-CA-LR-DA
732740	OMNIA-TARGA/ O.NOVO	EN 14688:2006 CL 25 OF-CA-LR-DA
735845	AVENTO	EN 14688:2006 CL 25 OF-CA-LR-DA
7358U4	AVENTO	EN 14688:2006 CL 25 OF-CA-LR-DA



OPTIMAL CARE

FOR YOUR BATHROOM

*Information and tips on how to care
for Villeroy & Boch products*



TREAT QUALITY WITH CARE

A clean and well-maintained bathroom is a pleasure to behold. To keep everything looking like new for as long as possible, appropriate care is required.

You can find lots of information here to help you look after different surfaces, furniture, taps and fittings. As well as a few tips from our employees' extensive practical experience and our latest research findings.

We wish you many years of pleasure with your Villeroy&Boch products.

CERAMIC		WELLNESS		FURNITURE, TAPS&FITTINGS	
General ceramics	4-5	Acrylic	14-15	Wooden bathroom furniture	18-21
CeramicPlus	6-9	Quaryl®	16-17	Taps&fittings	22-23
TitanCeram	10-11				
AntiBac	12-13				

CERAMIC

The modern classic

Villeroy&Boch ceramics stand for high-quality, easy-to-clean products with excellent hygiene properties. The specially developed glaze is an important feature, ensuring a highly resistant surface, perfect impermeability and maximum temperature resistance.

BENEFITS OF VILLEROY&BOCH CERAMICS

Ceramics impress with outstanding hygiene properties combined with high temperature stability and excellent stain resistance. Ceramics are also resistant to both impact and scratches and have a non-slip effect. These easy to maintain surfaces are available in a variety of modern colours and décors.

CLEANING AND CARE

Villeroy&Boch ceramic sanitaryware has a smooth, dense and virtually scratch-proof surface that is resistant to all common household acids and alkalis. Clean water and a damp cloth are often all you need for everyday care. Water marks, residual grease or soap can be removed easily using a bathroom cleaner. This also allows quick and easy removal of limescale deposits.

Another option is a gentle limescale remover from a specialist retailer, which can be used according to the manufacturer's recommendations.

Particular caution is required with substances containing high amounts of fluorine, for example, rust removers or toothpastes. If they are not removed, they can lead to the formation of stains. Remove any residue immediately! For heavier contamination, we recommend a non-abrasive liquid or cream bathroom cleaner. For even more effective results, apply the product using a soft, non-scratch sponge.

IMPORTANT INFORMATION

Please read the manufacturer's recommendations for use carefully. If in doubt, test the cleaning or care product on a concealed area first.

It is very important to avoid very aggressive cleaning products that could damage the ceramic surfaces, for example:

- Scouring creams or powders
- Concentrated drain cleaners
- Tap and steel cleaners
- Powder toilet cleaners

We recommend that you do not use these products at all or, in the case of drain cleaners, tap cleaners or steel cleaners, avoid direct contact with ceramic surfaces.

CERAMICPLUS

Less cleaning – more time to enjoy life



Flow properties of liquids on a conventional ceramic surface.



Liquids flow off CeramicPlus faster: the ceramics stay cleaner.



Dirt and limescale adhere more easily to conventional ceramics.



CeramicPlus makes it very difficult for dirt to adhere. Easy cleaning, even with dried-on limescale.

THE HYGIENIC SURFACE FINISH

Your new ceramic product looks sensational – and it is equally easy to care for. As well as choosing outstanding design and premium quality, you have also purchased a very low maintenance product: CeramicPlus is an innovative development from the Villeroy&Boch research laboratory, inspired by the latest findings from material science research.

BENEFITS OF VILLEROY&BOCH CERAMICPLUS

Villeroy&Boch has managed to improve the properties of ceramics, using a special process to give CeramicPlus ceramic a lasting finish. Water forms droplets on contact with CeramicPlus, which then roll faster and more easily down the drain, carrying with them particles of limescale and dirt.

CeramicPlus is durable, scratch-proof and insensitive to acids and alkalis. CeramicPlus products impress with their excellent hygiene properties and wide variety of colours.

MORE EFFICIENT CLEANING THANKS TO CERAMICPLUS

- 80% less cleaning time*
- 90% less cleaning agent*
- 90% less water consumption**

* for the removal of limescale in comparison to standard Villeroy&Boch ceramics, wfk - Institut für Angewandte Forschung GmbH (wfk - Institut for Applied Research), WL 7478/15 dated 30 April 2015

** for the removal of slurry in comparison to standard Villeroy&Boch ceramics, wfk - Institut für Angewandte Forschung GmbH (wfk - Institut for Applied Research), WL 7478/15 dated 30 April 2015

CERAMICPLUS

CLEANING AND CARE

CeramicPlus is considerably easier to clean than conventional ceramics.

For everyday care of your ceramics, we recommend a soft, non-scratch sponge or cloth and clean water.

If you wish to use a cleaning product, choose a standard all-purpose cleaner. Do not use aggressive, abrasive or environmentally harmful products.

Even stubborn dirt or dried-on limescale are no cause for concern. Benefit: CeramicPlus' easy-care properties help you to ensure optimal hygiene and fresh, clean surfaces in an environmentally-friendly way without the need for aggressive detergents. A real advantage in the bathroom! Tested and confirmed by the wfk Forschungsinstitut für Reinigungstechnologie. To treat heavier soiling, we generally recommend a mild bathroom cleaner or mild all-purpose cleaner.

In the case of very stubborn dirt, simply leave the bathroom cleaner or limescale remover to act overnight. Gel or foam cleaners are ideal, as they also adhere well to sloping surfaces. Or: simply place a cloth soaked in cleaning agent over the stain.

IMPORTANT INFORMATION

CeramicPlus is resistant to all common household acids and alkalis (including cosmetic products and medicines containing solvents, alcohol or acetone).

Like all ceramic surfaces, CeramicPlus will be damaged by repeated use of: scouring creams or powders, concentrated drain cleaners, tap and steel cleaners or bleach products containing chlorine.

TIP: Dampen microfibre cloths slightly before use and rinse them out regularly.





TITANCERAM

Ceramics from master craftsmen

TitanCeram is an innovative Villeroy&Boch material that incorporates all the experience we have gained in more than 265 years of ceramic manufacture. For the first time, the pioneering TitanCeram material permits the creation of products with uniquely precise designs, extremely thin walls and sharply defined edges.

BENEFITS OF VILLEROY&BOCH TITANCERAM

TitanCeram is easy to clean and particularly resistant to knocks, impact and scratches, heat and cold.

CLEANING AND CARE

TitanCeram can be cleaned with very little time and effort, just like normal ceramics. Clean water and a damp cloth are all you need for everyday care.



with **AntiBac**

without **AntiBac**

ANTIBAC

Lasting protection against bacteria



This innovative surface technology provides a significant improvement in hygiene properties. AntiBac reduces bacterial growth by more than 99.9%, offering long-lasting protection and a significant reduction in the use of chemical cleaning products. Very practical: the antibacterial effect is integrated directly in the glaze of the bathroom ceramics and toilet seats.

BENEFITS OF VILLEROY&BOCH ANTIBAC

AntiBac provides optimal and lasting protection as the silver ions integrated in the glaze maintain the antibacterial effect throughout the product's entire lifetime. Effective inhibition of bacterial growth by over 99.9% has been confirmed by the respected independent BOKEN Quality Evaluation Institute, the BAM (Bundesanstalt für Materialprüfung) and the IZORE (Centrum Infectieziekten Friesland, NL). AntiBac has been dermatologically tested and is harmless for the environment and health.

CLEANING AND CARE

AntiBac can be cared for in the same way as normal ceramics. Clean water and a damp cloth are all you need for everyday care.



ACRYLIC

45 years of expertise

Villeroy & Boch has been producing high-quality acrylic products since 1969, underpinned by more than 265 years of innovative strength and design expertise combined with stringent quality standards and a diverse selection. Acrylic stands for optimal comfort and a wide variety of designs.

BENEFITS OF VILLEROY&BOCH ACRYLIC

Villeroy & Boch's high-quality sanitary acrylic is colour-fast and offers impressively durable quality. Acrylic has an insulating effect, its smooth surfaces are easy to clean and they retain their shine for a long time. VILBOgrip gives the surfaces a very non-slip effect.

CLEANING AND CARE

Acrylic surfaces are very easy to clean thanks to their smooth, non-porous finish. All that is needed to maintain their shine is regular care using standard domestic non-scratch liquid cleaning products.

Vinegar or standard limescale cleaners can be used to remove limescale marks easily.



QUARYL®

Nature perfected



Available exclusively from Villeroy&Boch, Quaryl® combines the best properties of quartz with the variability of acrylic resin. It lends itself to new shapes, radii and edges to meet the most demanding design requirements and its smooth non-porous, surface is particularly hygienic, pleasant to the touch and easy to care for.

BENEFITS OF VILLEROY&BOCH QUARYL®

Villeroy & Boch's Quaryl® allows impressively precise radii and edges, and is very stable and rigid. This solid-colour material is resistant to knocks, impact, scratches and UV. The smooth, non-porous, solid surfaces make it very difficult for dirt to adhere. They are easy to clean and retain their shine even after many years of use. Its good thermal insulation makes Quaryl® feel pleasantly warm to the touch. It also offers unparalleled non-slip properties (tested by the TÜV-LGA) and the solid material's sound-absorbing effect provides enhanced comfort.

CLEANING AND CARE

Quaryl® surfaces are very easy to clean thanks to their smooth, non-porous finish. All that is needed to maintain their shine is regular care using standard domestic non-scratch liquid cleaning products.

Vinegar or standard limescale cleaners can be used to remove limescale marks easily.



BATHROOM FURNITURE

Beauty and practicality combined

The surfaces of Villeroy&Boch bathroom furniture consist of materials such as sealed, varnished wood, hard-wearing laminates or direct coatings, films, paint or veneers. Real wood and real wood veneers are natural products, Variations in colour, structure, grain or small knots and inclusions are not quality flaws, rather evidence of the material's natural composition.

CLEANING AND CARE

- Wipe **bathroom furniture** using a soft clean cloth, dampened with lukewarm water and a gentle household cleaner (e.g. diluted washing-up liquid), applying only very gentle pressure.
- Use a chamois dampened with lukewarm water to wipe **mirrored surfaces**. Wipe the edges of mirrors dry.
- Wipe **leather and synthetic leather** using a microfibre cloth dampened with lukewarm water.
- Wipe **metal surfaces** using a soft cloth dampened with lukewarm water and a gentle household cleaner (e.g. diluted washing-up liquid).
- Use a microfibre cloth and a non-abrasive stainless steel cleaner to clean **stainless steel components**. Spray the cleaner onto the cloth and then wipe the components.
- **Natural stone tiles** have been impregnated and can be cleaned in the same way as furniture. Please refer to the separate instructions including information for marble tiles, too.

BATHROOM FURNITURE

- **Artificial stone tiles** can be buffed up using polish (e.g. car polish).
- Clean **flocking** using a soft brush and household cleaner.
- **Acrylic surfaces** can be buffed up using alcohol-free polishes (e.g. car polish). However, solvents should not contain methylbenzene or acetone or be based on a window cleaning product.
- Always switch **electrical items** off before cleaning them with a dry cloth.

IMPORTANT INFORMATION

- Furniture surfaces should not remain covered by pools of water or exposed to moisture for prolonged periods. Wipe the surfaces using a dry cloth.
- All surfaces have limited UV resistance. Constant exposure to UV radiation may result in discolouration.
- Avoid contact with abrasive, pointed or sharp objects.
- Remove chemicals such as hair dyes, descaling agents, nail polish remover, perfumes, etc. from furniture surfaces immediately.
- * Do not use any abrasive or acidic cleaners or cleaning products containing solvents or oils! Always wipe dry!
- If you are using a cleaning product, check the label to make sure it is suitable for the material you intend to clean. Test the product on an inconspicuous area before using it for the first time.

- After each use, we recommend that you rinse off any soap marks and dry the surface carefully using a soft, clean cloth. This will help to preserve the surface of your Villeroy&Boch product and prevent water marks.
- Any areas of damage on painted, powdered or veneered surfaces or furniture parts covered with laminate must be sealed as quickly as possible to prevent any further damage.

WARNING! Efficient ventilation and extraction in the bathroom are essential to maintain your furniture's quality and appearance.

TAPS & FITTINGS

Enhanced aesthetics

Elegantly flowing, classically simple or puristic – Villeroy & Boch's stylish taps and fittings create a special atmosphere in your bathroom. And appropriate care will maintain this effect for a long time.



La Fleur



L'Aura



Just



Cult

CLEANING AND CARE

- **Regular cleaning** of taps and fittings is important to prevent any build-up of limescale.
- Make sure that the **cleaning products** you use are suitable for the application in question.
- Never leave **cleaning products** to work for longer than necessary.
- Use a soft cloth to wipe off **drops of water** after each use.
- Never spray **cleaning solution** directly onto taps or fittings. Spray it onto the cleaning cloth or sponge instead.
- Remove any **remnants of toiletries** such as shampoo, shower gel or liquid soap quickly to avoid any damage.
- A thin protective film should be applied regularly to **varnished and galvanised surfaces**. We recommend using a special preserving agent designed specifically for varnished or galvanised surfaces.

IMPORTANT INFORMATION

Do not use any products containing hydrochloric acid, formic acid or acetic acid as these can lead to damage. The same applies to chlorine-based bleach cleaning products.

Never mix cleaning products.

Do not use any abrasive products or tools (scouring cream, microfibre cloths).

Cleaning products containing phosphoric acid are recommended only to a limited extent.

VILLEROY & BOCH

GERMANY

*Villeroy & Boch AG
Bathroom and Wellness Division
Headquarters
66693 Mettlach*

*Tel. +49 (0) 68 64-81-0
Fax +49 (0) 68 64-81-1484*

