

Guarantee

For any technical or installation queries please contact VADO on 01934 745163. This product is guaranteed against manufacturing defects from the date of purchase until the expiry of the relevant guarantee period shown below.

The guarantee is only valid if:-

1. The product has been installed, used and maintained in accordance with VADO's instructions and subjected to normal use only.
2. The defect is not due to use of an unsuitable or inadequate water or power supply.
3. The defect is not due to accident, misuse, neglect or repair other than by VADO or VADO authorised agents or damage caused by foreign objects or substances.
4. You have registered your warranty on the VADO website within six months of purchase.

Under this guarantee (which is non-transferable) VADO will, at its option, repair or replace free of charge any product (or replacement part) found to be defective. The guarantee does not extend to any consequential loss or damage. After repair or replacement the relevant guarantee period will be calculated from the original date of purchase.

The relevant guarantee periods are:-

VADO chrome products have a 12 year guarantee.

VADO digital products have a 6 year guarantee.

All other VADO products and spares have a 3 year guarantee.

VADO electric showers have 2 year guarantee.

All claims under the guarantee must be submitted in writing to the person who supplied the product to you and must be received no later than the last day of the relevant guarantee period. All claims must be accompanied by proof of purchase (sales receipt or delivery note).

VADO operates a policy of continuous product development and therefore reserves the right to change the product, packaging and documentation specifications without notice.

This guarantee is in addition to and does not affect your statutory rights as a consumer.

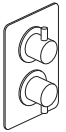

Concealed Thermostatic Mixing Valve - 2 way User Guide



Welcome

Thank you for choosing VADO

Our products can be found in some of the most prestigious hotel, commercial and residential developments across the world, therefore you can expect exceptional product quality and outstanding customer service.

This product has passed through stringent quality assurance processes coupled with demanding lifecycle mechanical testing to ensure it is recognised by the NSF TMV2 Scheme and reaches the exacting standards that allow us to offer our premium 12 year guarantee. *

To ensure this product operates at its optimum efficiency, it is essential this product is maintained and serviced in accordance with these instructions.

We work to ensure our product designs are harmonious with all sanitaryware, so when you choose VADO, your choice of coordinating items is unlimited.

With VADO, you can really let your inspiration flow.

For any technical or operational queries please contact our experienced aftersales team on 01934 745163.

* This product has been certified as meeting the requirements of BS EN 1111 under approval number NSF1913.

Vado, Wedmore Road, Cheddar, Somerset, England BS27 3EB
tel 01934 744466. fax 01934 744345
aftersales@vado.com
www.vado.com

Parts:

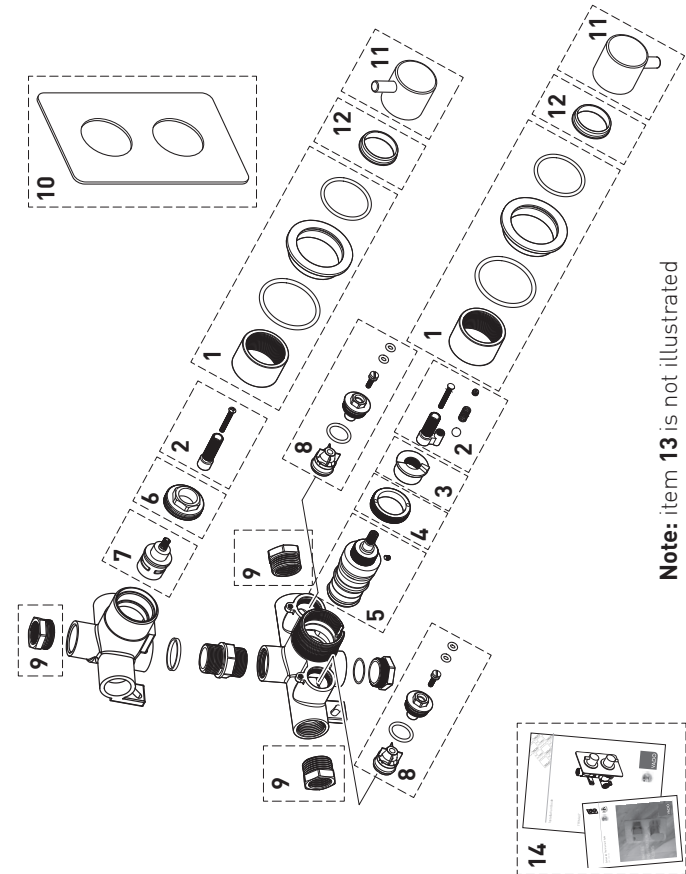

Parts list:

Item	Description	Part Code	Quantity
11	Handles for CEL	CEL-1/FLOW-D-C/P CEL-1/TEMP-D-C/P	1 pair
	Handles for PHA	PHA-1/FLOW-D-C/P PHA-1/TEMP-D-C/P	
	Handles for PHO	PHO-1/FLOW-D-C/P PHO-1/TEMP-D-C/P	
	Handles for LIF	LIF-1/FLOW-D-C/P LIF-1/TEMP-D-C/P	
	Handles for MIX	MIX-1/FLOW-D-C/P MIX-1/TEMP-D-C/P	
	Handles for NOT	NOT-1/FLOW-D-C/P NOT-1/TEMP-D-C/P	
	Handles for ORI	ORI-1/FLOW-D-C/P ORI-1/TEMP-D-C/P	
	Handles for ELE	ELE-1/FLOW-D-C/P ELE-1/TEMP-D-C/P	
12	Handle Spacer	CON-148HANDLE-SPACER	2
13	Grub Kit	CON-148-GRUBKIT	1
14	Installation guide & User manual		1

Operation

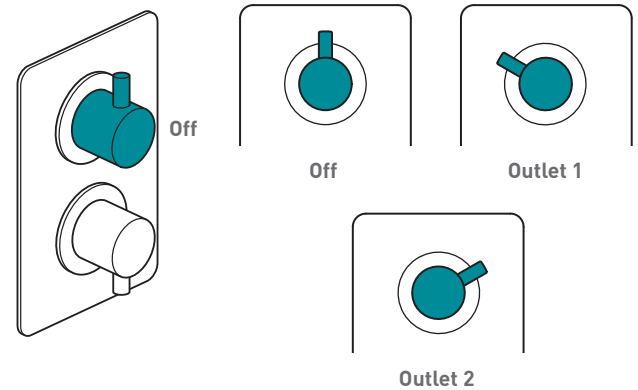

Turning the flow control handle to the required position increases the flow of water

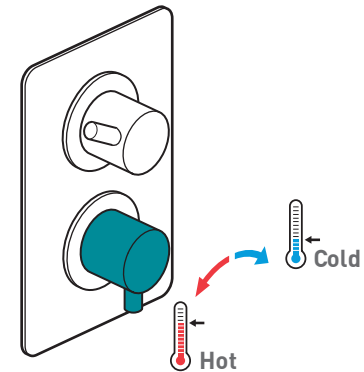

Turning the temperature control handle in the direction of the arrows increases/decreases the temperature

Servicing:

It is a requirement that all TMV2 approved valves shall be verified against the original set temperatures results once a year. When commissioning/testing is due the following performance checks shall be carried out.

Measure the mixed water temperature at the outlet.

Carry out the cold water supply isolation test by isolating the cold water supply to the TMV2, wait for five seconds if water is still flowing check that the temperature is below 46° C.

If there is no significant change to the set temperature ($\pm 2^{\circ}\text{C}$ or less from the original settings) and the fail-safe shut off is functioning, then the valve is working correctly and no further service work is required.

Notes:

If there is a residual flow during the commissioning or the annual verification (cold water supply isolation test), then this is acceptable providing the temperature of the water seeping from the valve is no more than 2°C above the designated maximum mixed water outlet temperature setting of the valve.

Temperature readings should be taken at the normal flow rate after allowing for the system to stabilise.

The sensing part of the thermometer probe must be fully submerged in the water that is to be tested.

Any thermostatic mixing valve (TMV) that has been adjusted or serviced must be re-commissioned and re-tested in accordance with the manufacturers instructions.

See vado.com for more information.

Parts list:

Item	Description	Part Code	Quantity
1	Fixing Ring Kit	CON-148-SHROUDS	1
2	Spindle Kit	CON-148-SPINDLE-KIT	1
3	Stop Ring	CON-148-STOP-RING	1
4	Locking Ring - Temp Cartridge	CON-148-TEMPLOCKRING	1
5	Temperature Cartridge	V-001C-PLA	1
6	Locking Ring - Diverter Cartridge	CON-148-DIV-LOCKRING	1
7	Diverter	FL-804-33/3X	1
8	NRV + Isolator kit	CON-148-NVR-KIT	1
9	Adaptors	CEL-CON-3/4MX1/2F-BR	1
10	Plate for: CEL-148D/SQ, PHA-148D, PHO-18D	CEL-0024/SQ-D-C/P	1
	Plate for: MIX-148D, NOT-148D	MIX-0024/SQ-D-C/P	1
	Plate for: LIF-148D	LIF-0024/SQ-D-C/P	1
	Plate for: CEL-148D/RO/, ELE-148D, ORI-148D	CEL-0024/RO-D-C/P	1

Cleaning instructions:

The electroplating on this product is finished to the highest standard. Due care needs to be taken to ensure the appearance is retained.

We recommend cleaning all products with a soft damp cloth ONLY and advise strongly against the use of all aggressive/corrosive cleaning products i.e. powders and liquids. If these instructions are not followed, this may invalidate your guarantee in the event of a problem occurring.

Maintenance:

We advise that the below is carried out annually as failure to do so may result in invalidation of warranty.

Shut off the water supply to both hot and cold inlets, before commencing any maintenance work below.

See isolation procedure on page 7.

Thermostatic cartridge

This thermostatic valve is fitted with a single filtering facility.

Filters are fitted on the thermostatic cartridge.

Depending on the water quality, filters may become dirty, causing reduced flow and inefficient working of the valve.

To clean the filters, you must first remove the cartridge from the housing.

Removing the Cartridge

1. Shut off the water supply to both inlets at the isolating valves. Ensure the thermostatic valve has been successfully isolated. See page 7 for correct procedure.

2. Remove the temperature control handle. Remove the screw from the temperature stop arm and pull off. Pull off the stop ring.

Pull off the plate securing ring and unscrew the shroud. Using a pair of long-nosed pliers unscrew the securing ring and remove.

For more information see the installation manuals.

3. Pull out the thermostatic cartridge.

4. Clean filters by rinsing them under running water to remove any debris.

5. If there is limescale deposits then it is recommended to immerse the cartridge for a few minutes in 50% white vinegar + 50% hot water, brush the filters gently and then rinse under running water to clean all particles. If this is not effective, a replacement cartridge should be fitted.

Maintenance:

6. Before reassembling the cartridge, clean its housing with a wet cloth and grease the 'O' rings using a suitable silicone grease, insert the thermostatic cartridge.
 7. Screw the securing nut on and tighten using long-nose pliers, careful not to overtighten.
 8. Place the temperature stop ring on the cartridge so the step is located at 12 o'clock.
 9. Turn the water supply on via the isolating valves.
 10. Check the water temperature to ensure correct commissioning.
- See page 8 of the Trim Kit instructions or Vado.com for commissioning.**
11. Replace shrouds, plate, securing ring, stop arm and handle.
 12. Secure the handle (see page 10 of Trim kit installation).

Isolation procedure:

IMPORTANT:

Please see the below procedure for isolating concealed thermostatic valves.

1. Remove handles/faceplate and trim parts allowing access to the isolation points on the valve.
2. Screw down the isolation screws clockwise until you feel a resistance (taking care not to over tighten).
3. Turn shower on to check isolation, please ensure that your body/hands are not under the flow of water as there is a potential for delivery of hot water.
4. Remove temperature stop ring (essential).
5. With shower in the on position, replace temperature handle on thermostatic valve (ensure temperature stop ring has been removed).
6. Turn temp handle fully anti-clockwise until stop point is reached and can be turned no further, please ensure that your body/hands are not under the flow of water as there is potential for delivery of hot water if isolation has been unsuccessful.
7. Turn temperature handle fully clockwise until you feel a resistance.
8. If there is no flow of water coming from the outlet during both points 6 and 7 isolation has been successful, you may now remove and maintain the thermostatic cartridge.
9. If at any of the above points water continues to flow please isolate at an alternative point within the system for both hot and cold and repeat points 3-9.

SPECIFICATION SHEET

COLLECTION: ELEMENTS

PRODUCT CODE: IND-ELE148D/2-BLK

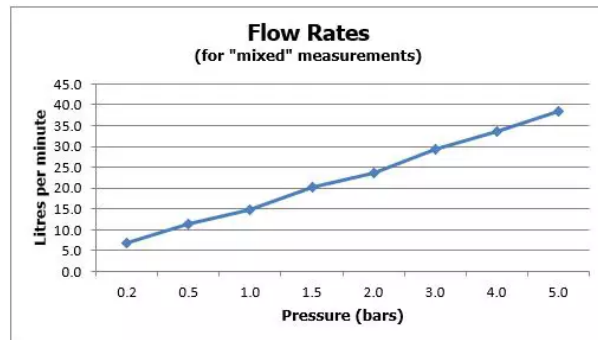
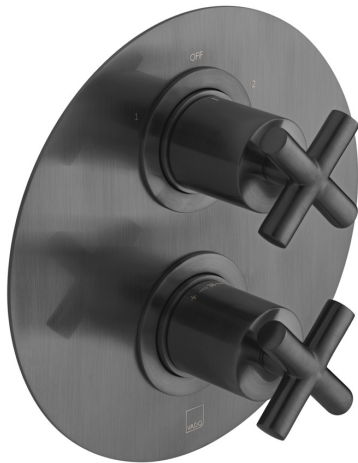

SHOWER TYPE

Shower Valve

VALVE TYPE

Concealed

ORIENTATION

Vertical

NUMBER OF OUTLETS

1 Outlet

WITH ALL-FLOW FUNCTION

No

WITH INTEGRATED DIVERTER

No

COMPATIBLE WITH STUDFAST

Yes

WITH BLEED VALVE FOR SYSTEM FLUSH ON INSTALLATION

Yes

WITH SHOWER KIT

No

tel: 01934 744466
email: sales@vado.com
www.vado.com

WHERE INSPIRATION FLOWS
TAPS | SHOWERS | ACCESSORIES



SPECIFICATION SHEET

COLLECTION: ELEMENTS

PRODUCT CODE: IND-ELE148D/2-BLK

INCLUDES MORTAR / TILE GUARD

Yes

COMPATIBLE WITH EASY-FIX BRACKETS

No

WITH THERMOSTATIC TECHNOLOGY

Yes

INSTALLATION TOLERANCES

min-max wall mount 70-95mm optimum installation depth 82mm

CONNECTIONS / FITTINGS

2 x 3/4" female inlets 2 x 3/4" female outlets includes 3/4" - 1/2" adaptors

SPARE PARTS

thermostatic cartridge V-704-34S diverter cartridge C-803-33X/3X

MOUNTING

Wall Mounted

PLUMBING SYSTEM SUITABILITY

Gravity System, Pumped System, Combination Boiler, Pressurised System

COLLECTION NAME

Elements

FINISH

Brushed Black

MINIMUM OPERATING PRESSURE

0.2 Bar LP (Shower) / 1.0 Bar MP (Bath)

GUARANTEE

15 Year Guarantee

tel: 01934 744466
email: sales@vado.com
www.vado.com

WHERE INSPIRATION FLOWS
TAPS | SHOWERS | ACCESSORIES



TECHNICAL DRAWING

COLLECTION: ELEMENTS

PRODUCT CODE: IND-ELE148D/2-BLK

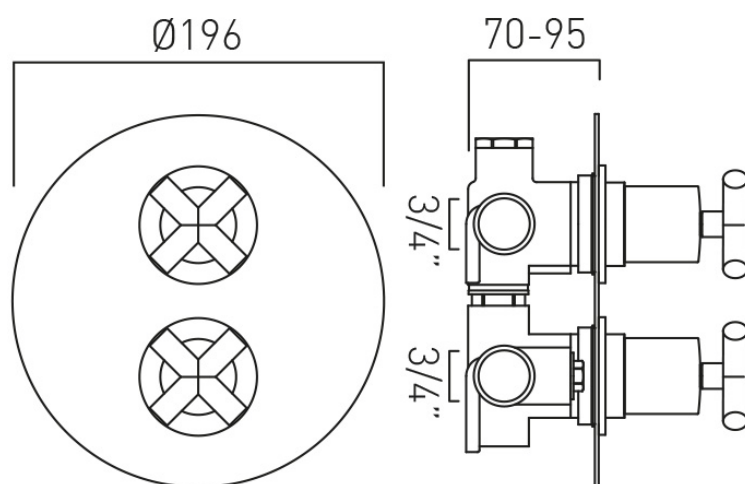

tel: 01934 744466
email: sales@vado.com
www.vado.com

WHERE INSPIRATION FLOWS
TAPS | SHOWERS | ACCESSORIES

