

SPECIFICATION SHEET

COLLECTION: KNURLED ACCENTS
PRODUCT CODE: IND-ORI200/SB-BRNK

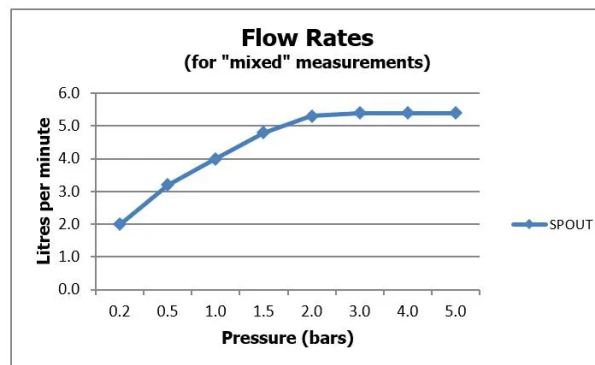

TAP TYPE

Basin Mixer

COLLECTION NAME

Knurled Accents

FINISH

Brushed Nickel

RECOMMENDED FLOW REGULATOR

5 l/m flow regulator fitted as standard

MINIMUM OPERATING PRESSURE

1.0 Bar MP

GUARANTEE

15 Year Guarantee

HANDLES

Single Lever

WITH ECOTURN COLD START TECHNOLOGY

No

WITH WATER FLOW STRAIGHTENER

No

tel: 01934 744466
email: sales@vado.com
www.vado.com

WHERE INSPIRATION FLOWS
TAPS | SHOWERS | ACCESSORIES



SPECIFICATION SHEET

COLLECTION: KNURLED ACCENTS
PRODUCT CODE: IND-ORI200/SB-BRNK

WITH WATER FLOW AERATOR

Yes

CONNECTIONS / FITTINGS

2 x 1/2" 400mm flexipipe connections

SPARE PARTS

ceramic cartridge C-010-N25

DECK HOLE DRILL DIAMETER

35mm

STYLE

Knurled

HOLES

1 hole

MOUNTING

Deck Mounted

PLUMBING SYSTEM SUITABILITY

Pumped System, Combination Boiler, Pressurised System



TECHNICAL DRAWING

COLLECTION: KNURLED ACCENTS
PRODUCT CODE: IND-ORI200/SB-BRNK

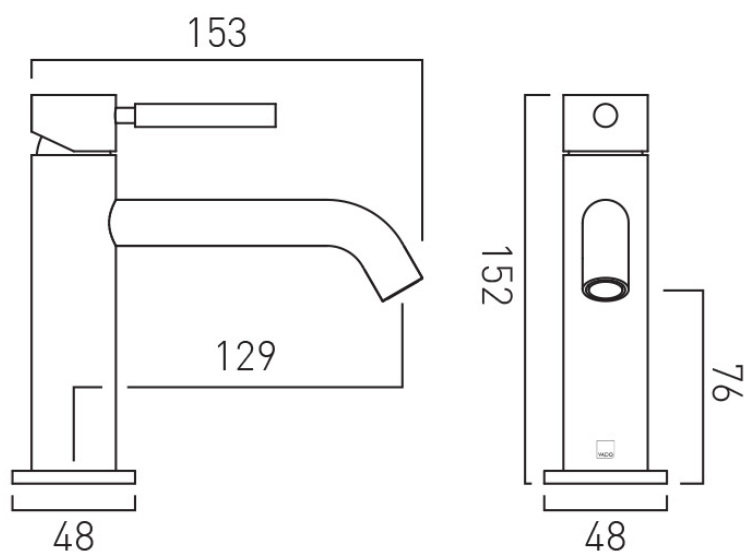

Guarantee

All VADO products come with a 2 year guarantee as standard. Within this guarantee period VADO will provide replacement parts and any labour **[SEE NOTE 1]** needed to complete the product repair.

This standard guarantee may be extended by registering your product to give the following guarantee periods, once registered:

Brassware products from the Individual by VADO collection have a 15 year guarantee (2 years parts and labour plus 13 years parts only).

VADO Sensori SmartTouch and SmartDial products have a 5 year guarantee (parts and labour).

VADO Identity and i-tech products have a 5 year guarantee (2 year parts and labour plus 3 years parts only).

All other VADO products have a 3 year guarantee (2 years parts and labour plus 1 year parts only)

[SEE NOTE 2].

Guarantee Conditions

Our products are guaranteed against manufacturing defects from the date of purchase until the expiry of the relevant guarantee period shown above.

The guarantee is only valid if:

- The product has been installed, used and maintained in accordance with VADO's instructions and subjected to normal use only.
- The defect is not due to use of an unsuitable or inadequate water or power supply.
- The defect is not due to accident, misuse, neglect or incorrect/inappropriate repair (other than by VADO or VADO authorised agents) or damage caused by foreign objects or substances.
- The extended guarantee is only available if you have completed the Guarantee

Registration Process.

This can be done via the VADO website or via phone to our aftersales team.

Registration must be completed within 6 months from date of purchase.

Under the extended guarantee period VADO will, at its option, offer to supply any replacement product (or component part) assessed to be defective **[SEE NOTE 3]**.

The guarantee (whether standard or extended) is non-transferable to any subsequent owner.

All claims under the guarantee should be notified in the first instance to our Aftersales department, contact details below, this must be done no later than the last day of the relevant guarantee period.

All claims must be accompanied by proof of purchase (sales receipt or delivery note) from an official VADO dealer.

The guarantee does not extend to any consequential loss or damage.

After repair or replacement, the relevant guarantee period will be calculated from the original date of purchase.

VADO operates a policy of continuous product development and therefore reserves the right to change the product, packaging and documentation specifications without notice. E&OE.

NOTES:

[1] Labour via our engineer network is only available in the UK. Attendance by a VADO engineer or sub-contract engineer will be under our standard terms and conditions.

[2] VADO spare parts and shower hoses are under a parts only guarantee.

[3] VADO reserves the right to charge in advance for a product (or replacement part) pending collection and investigation (at VADO expense) to confirm a defect is due to a manufacturing issue.

If a defect is found the charge will be refunded or cancelled.

This guarantee is in addition to and does not affect your statutory rights as a consumer.

Tel: 01934 745163

Email: aftersales@vado.com

KEEP FOR
FUTURE REFERENCE

15
year guarantee

ORIGINS

—

MONO BASIN MIXER
USER GUIDE



INDIVIDUAL

by VADO

Welcome

Thank you for selecting Individual by VADO.

Each timeless finish has been tailored to inspire your individual style, ready for you to create a contemporary look that will stand the test of time.

Coupled with our leading 15 year guarantee, this premium product has passed through stringent quality assurance processes to allow you to complete your look with confidence.

Our outstanding customer service, large scale development support and prestigious project history has ensured a globally trusted reputation. For any technical or operation queries, please contact our experienced Aftersales team on 01934 745 163.

Cleaning instructions:

The physical vapor deposition coating on this product is finished to the highest standard. Due care needs to be taken to ensure the appearance is retained. We recommend cleaning all products with a soft damp cloth **ONLY** and advise strongly against the use of all aggressive/corrosive cleaning products i.e. powders and liquids. If these instructions are not followed, this may invalidate your guarantee in the event of a problem occurring.

The aerator can be cleaned using vinegar or diluted essence of vinegar or vinegar based household cleaners. Stubborn scale can be removed mechanically, e.g. with an old toothbrush. We do not recommend bleach based chemical household cleaners.

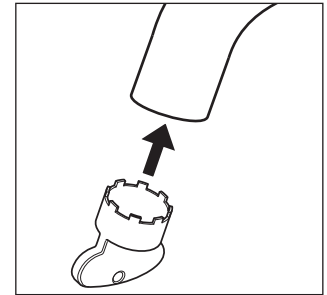

Should the aerator need to be removed or replaced, please call our experienced aftersales team on 01934 745163 to request an aerator key quoting part No. N-006-16-0-PLA.

Operation

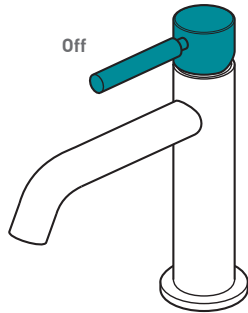

Lever in the Off position

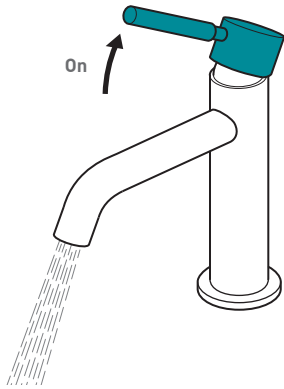

Moving the mixer lever upwards will increase the flow of water.

Operation

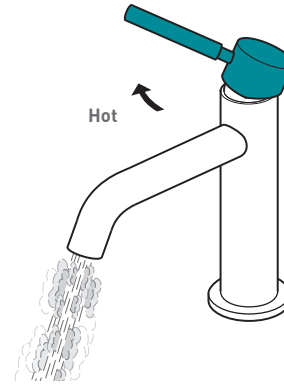

Moving the mixer lever to the left will increase the water temperature.

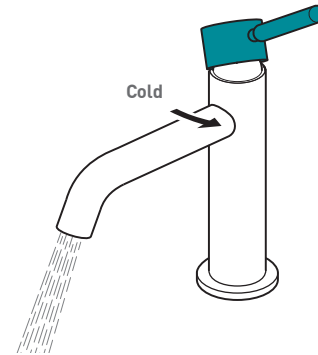
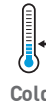

Moving the mixer lever to the right will decrease the water temperature.

Notes:

Notes: