

SPECIFICATION SHEET

COLLECTION: AXBRIDGE
PRODUCT CODE: BC-AXB-233-BN

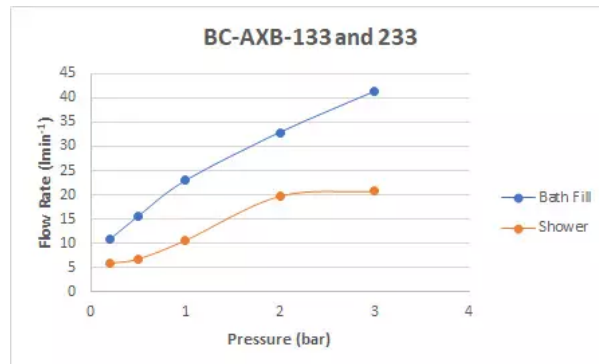

TAP TYPE

Bath Shower Mixer

WITH SHOWER KIT

Yes

WITH EASY-FIT BRACKETS

No

WITH INTEGRATED DIVERTER

No

WITH THERMOSTATIC TECHNOLOGY

No

FOR USE WITH BATH FILLER WASTE AND OVERFLOW

No

WITH BATH SPOUT

No

WITH AIR-INJECTION TECHNOLOGY

No

WITH WATER FLOW STRAIGHTENER

Yes

tel: 01934 744466
email: sales@vado.com
www.vado.com

WHERE INSPIRATION FLOWS
TAPS | SHOWERS | ACCESSORIES



SPECIFICATION SHEET

COLLECTION: AXBRIDGE
PRODUCT CODE: BC-AXB-233-BN

WITH WATER FLOW AERATOR

No

CONNECTIONS / FITTINGS

2 x 3/4" female threaded connections

SPARE PARTS

cold ceramic cartridge FL-511-RTC hot ceramic cartridge FL-511-LTC

STYLE

Traditional, Lever Handles

HOLES

2 Hole

MOUNTING

Floor Mounted

PLUMBING SYSTEM SUITABILITY

Pumped System, Combination Boiler, Pressurised System

COLLECTION NAME

Axbridge

FINISH

Bright Nickel

MINIMUM OPERATING PRESSURE

1.0 Bar MP

GUARANTEE

15 Year Guarantee

TECHNICAL DRAWING

COLLECTION: AXBRIDGE
PRODUCT CODE: BC-AXB-233-BN

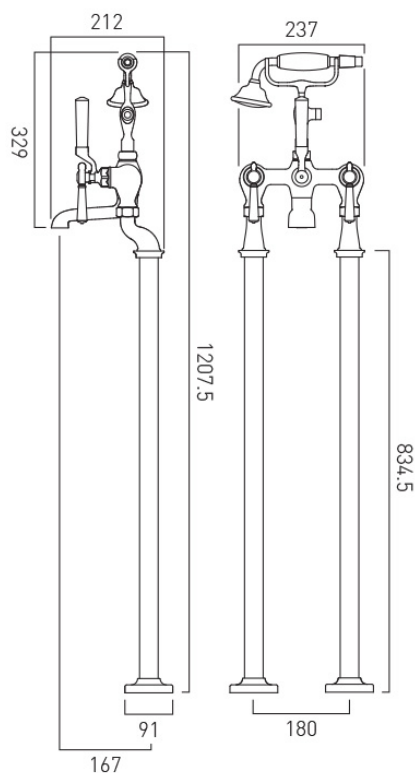

tel: 01934 744466
email: sales@vado.com
www.vado.com

WHERE INSPIRATION FLOWS
TAPS | SHOWERS | ACCESSORIES



Guarantee

All VADO and Booth & Co. products come with a 2 year guarantee as standard. Within this guarantee period VADO will provide replacement parts and any labour **[SEE NOTE 1]** needed to complete the product repair.

This standard guarantee may be extended by registering your product to give up to a 15 year guarantee period. Once registered:

VADO chromed brassware and stainless steel products have a 12 year guarantee (2 years parts and labour plus 10 years parts only).

Individual by VADO and Booth & Co. products have a 15 year guarantee (2 years parts plus 13 years parts only) *with the exception of Sensori products (please see details of guarantee below).*

VADO Sensori Smart Touch and Smart Dial products have a 5 year guarantee (parts and labour).

VADO Identity and i-tech products have a 5 year guarantee (2 year parts and labour plus 3 years parts only).

All other VADO products have a 3 year guarantee (2 years parts and labour plus 1 year parts only) **[SEE NOTE 2].**

VADO electric showers have a 2 years parts and labour guarantee.

Guarantee conditions

Our products are guaranteed against manufacturing defects from the date of purchase until the expiry of the relevant guarantee period shown above.

The guarantee is only valid if:

- The product has been installed, used and maintained in accordance with VADO's instructions and subjected to normal use only.
- The defect is not due to use of an unsuitable or inadequate water or power supply.
- The defect is not due to accident, misuse, neglect or incorrect/inappropriate repair (other than by VADO or VADO authorised agents) or damage caused by foreign objects or substances.
- The extended guarantee is only available if you have completed the Guarantee Registration Process.

This can be done via the VADO website or via phone to our aftersales team. Registration must be completed within 6 months from date of purchase.

Under the extended guarantee period VADO will, at its option, offer to supply any replacement product (or component part) assessed to be defective **[SEE NOTE 3].**

The guarantee (whether standard or extended) is non-transferable to any subsequent owner. All claims under the guarantee should be notified in the first instance to our Aftersales department, contact details below, this must be done no later than the last day of the relevant guarantee period. All claims must be accompanied by proof of purchase (sales receipt or delivery note) from an official VADO dealer.

The guarantee does not extend to any consequential loss or damage.

After repair or replacement, the relevant guarantee period will be calculated from the original date of purchase.

VADO operates a policy of continuous product development and therefore reserves the right to change the product, packaging and documentation specifications without notice.

NOTES:

[1] Labour via our engineer network is only available in the UK. Attendance by a VADO engineer or sub-contract engineer will be under our standard terms and conditions.

[2] VADO spare parts and shower hoses are under a parts only guarantee.

[3] VADO reserves the right to charge in advance for a product (or replacement part) pending collection and investigation (at VADO expense) to confirm a defect is due to a manufacturing issue.

If a defect is found the charge will be refunded or cancelled. This guarantee is in addition to and does not affect your statutory rights as a consumer.

Tel: 01934 745163

Email: aftersalescare@vado.com

KEEP FOR
FUTURE REFERENCE

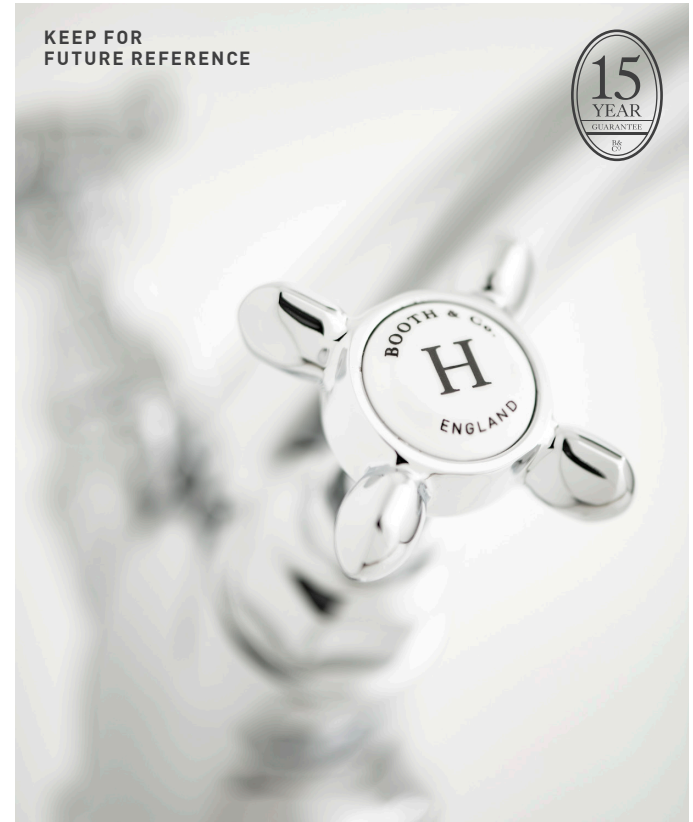

AXBRIDGE

FLOOR MOUNTED MIXER
USER GUIDE

BOOTH & Co.
ENGLAND

Welcome to Booth & Co.

Expertly designed in our home town of Cheddar, Somerset, each Booth & Co. product is as time-honoured on the outside as it is pioneering within.

Hand-crafted to exude a distinct, timeless sophistication, this product has passed through stringent quality assurance processes and demanding lifecycle mechanical testing to ensure an unrivalled quality.

Our leading 15 year guarantee certifies excellence within every detail.

Part of the VADO family, Booth & Co. retains the same outstanding customer service and large scale development support that earned VADO a globally trusted reputation. For any technical or operation queries, please contact our experienced Aftersales team on 01934 745 163.

Indulge in luxury as it should be.

VADO
Wedmore Road, Cheddar,
Somerset, England BS27 3EB
tel 01934 744466
fax 01934 744345
www.vado.com
sales@vado.com

Cleaning instructions:

The electroplating on this product is finished to the highest standard. Due care needs to be taken to ensure the appearance is retained.

We recommend cleaning all products with a soft damp cloth ONLY and advise strongly against the use of all aggressive/corrosive cleaning products i.e. powders and liquids. If these instructions are not followed, this may invalidate your guarantee in the event of a problem occurring.

Operation - cross handles



Hot

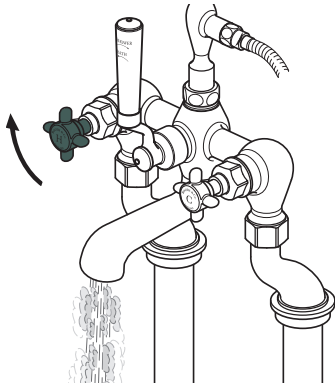

Turning the hot handle clockwise will increase the flow of hot water.

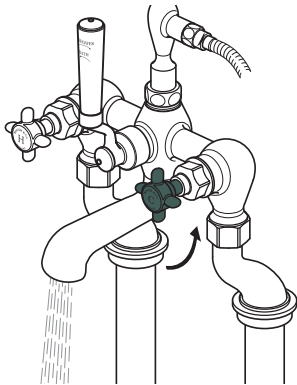

Cold

Turning the cold handle anti-clockwise will increase the flow of cold water.

Operation - lever handles



Hot

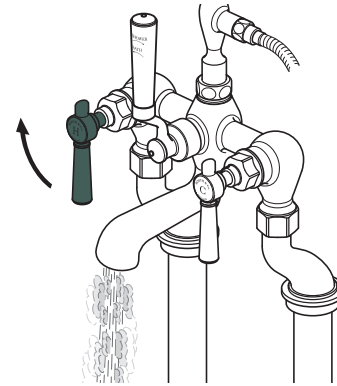

Turning the hot handle clockwise will increase the flow of hot water.

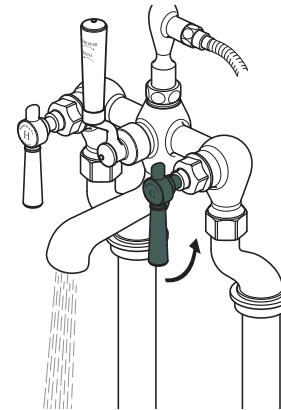

Cold

Turning the cold handle anti-clockwise will increase the flow of cold water.

Operation - diverter

Notes:

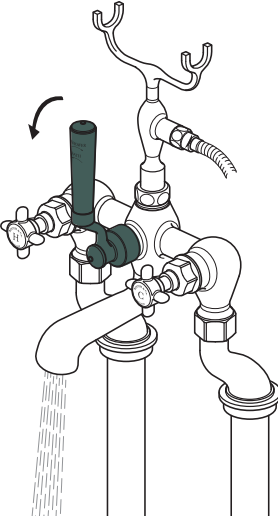

Turning the handle anti-clockwise will divert the flow of water to the spout.

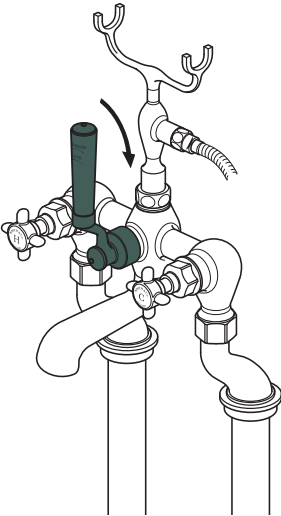

Turning the handle clockwise will divert the flow of water to the Handset